



CLAMPS REELS AND GAUGES

INDEX

INDUSTRIAL HOSE & SHEET RUBBER

PVC & PU HOSE		RUBBER & PU HOSE	
	<u>PAGE</u>		<u>PAGE</u>
PVC Pressure Hose	1-6	Pumpowa Rubber Layflat Hose	24
Safety Yellow Hose	1	Irrigation Hose	26-27
TPR (Translucent Pressure Hose)	1	Travelflex Rubber Irrigation Hose	26
Tradeflex Hose	1	Powaflex P.U. Irrigation Hose	27
Tradeflex Fitted Assemblies	2	Wellman Polyurethane Bore Hose	28-29
Chemflex Hose	2	General Rubber & Polyurethane Hose	30-46
Hi-Spray Hose	2	Air & Water Delivery Hose	30
White Washdown Hose	3	Water Suction/Delivery Hose	30
Medium Drag Hose	3	Rockdrill/Bull Air Hose (Airminer)	30-31
Greenflex Ag-Ind	3	FRAS Air & Water Delivery Hose	31
FRAS Hose	4	FRAS Water Suction/Delivery Hose	31
Divers Air Hose	4	Steel Braid Air Hose	32
Drum Pump Hose	4	Yellow Pneumatic Air Hose	32
PR Hose	4	Contractors' Air Hose Assembly	32
Fire reel Hose & Fire Hose Assemblies	5	Hot Air Suction & Delivery Hose	32
Fire Kits – Assembled	5	Powaflex 1200 Hi-Temp Steel Air Hose	32
Fire Hose Reel	5	Multi-Purpose Hose	33
Sullage Hose – Reinforced & Unreinforced	6	G.P. Air & Water Hose	33
Washing Machine Hose	6	Rubber Firereel Hose	33
Drop Hose	6	Air Brake Hose	34
Garden Hose	7-8	Fuel Line Hose	34
Gardenflex	7	Push-On Hose (SAE100R6)	34
Allrounder II	7	Marine Exhaust Hose	34
Olympic Goldflex	7	Fuel & Oil Delivery Hose	35
Raynbo 5 & Raynbo 10	8	Fuel & Oil Suction & Delivery Hose	35
Soaker Hose	8	Paint Fluid Hose	36
Tubing	9-11	Farm Tank Drum Pump	36
Clear Vinyl Tubing	9	Radiator Hose (Straight Length)	36
Beverage Tube	9	Car Heater Hose	36
Self Store Hose	10	Silicone Radiator Hose	37
Nylon Tubing	10-11	Silicone Heater Hose	37
PVC Suction Hose	12-17	Welding Hose	38
Grey, Blue, Black	12	Washdown Hose	39
Blue, Black & Slurry (Super Elastic)	12	Standard Steam Hose	39
Red, Flexisteel	14	Steel Steam Hose	39
M.D. Translucent Green	15	Brewers' Delivery Hose	40
M.D. Non-Toxic Clear	15	Brewers' Suction/Delivery Hose	40
Agpond	15	Chemical Suction & Delivery Hose	40
Air Seeder Hose	16	Sandblast Hose	41
Magflex	16	Powavac P.U.	41
Sanitary Suction Hose	16	Contractors' Water Suction Hose	41
Spa Hose	17	Bulk Material Delivery Hose	42
Swimming Pool Hose	17	Muff Coupling Hose	42
G Vac Hose	17	Concrete Delivery Hose (40 & 85 bar)	42
Ducting	18-19	Powaflex P.U. Concrete Placement Hose	43
DTPR/RFH	18	Mineral Recovery Hose	44
Extractaflex	18	FRAS Cable Protection Hose	44
Ductor	19	FRAS Stone Dusting Hose	44
Polyurethane Ducting	19	Material Handling Hose (Swaged Ends)	45
PVC Layflat Hose	20-21	Contractors Suction Pump Hose Assemblies	46
Hi-Flo Blue, Red & Green Layflat Hose	20	Airflat Assemblies	46
Blueline, Redline & Agflat Layflat Hose	21	Rubber Expansion Joints	47
Potable Water (Drinking Water) Hose	22-23	Hydraulic Hose	48
Potable Water Braided Pressure Hose	22	1 & 2 Wire Non Skive (1SN & 2SN)	48
Potable Water Suction Hose	23	Spiral Guard	49
Potable Water Layflat Hose	23	S/Steel & Composite Hose	50
Polyurethane & Rubber Layflat Hose	24-25	Sheet Rubber Products	51-52
Polyurethane Mine Pit Dewatering Hose	24	Natural & Neoprene Insertion/Sheet Rubber	51
Airflat Long Length Layflat Air Hose	25	Rib, Studded & Ute Matting	52
Petroleum Long Length Layflat Hose	25	Flange Gaskets & Tarp Rings	52
Fire Fighting Hose	25		
		SEE OVER FOR PAGES 53-220	

FITTINGS, VALVES, NOZZLES, CLAMPS, REELS, GAUGES

	<u>PAGE</u>		<u>PAGE</u>
Camlock Couplings	53-60	Valves	140-169
Aluminium Camlocks	53-55	AIP, AGA, WaterMark & Adflo Ball Valves	140
Nyglass Camlocks	56	Flomax Lever & T-Handle Ball Valves	141
Polypropylene Camlocks	57	Floman, Adflo Lockable, LH/RH tank fitting	142
Brass Camlocks	58	Polytank Standard Ball & Gate Valve	142
Stainless Steel Camlocks	59	3-Way 'L' & 'T' Port Ball Valves	143
Camlock Accessories	60	Kitz 3-Way & Bronze Ball Valves	144
General Fittings	61-85	Mini Ball Valves, Bibcocks, Fire Ball Nozzle	145
Brass & Polypropylene Hose Couplings	61	AGA Double Flared Gas Valve	145
Washers (To Suit Above)	61	Stainless Steel Ball Valves	146
Bauer Type Couplings – Standard Duty	62	3-Way 'L' & 'T' S/Steel Ball Valves	147
Bauer Type Couplings – Heavy Duty	63	Stainless Steel Gate Valve	147
Bauer Type Couplings Parts & Accessories	64	S/Steel Swing & Spring Check	148
Bauer Type Aluminium Split Strainers	64	Stainless Steel Y-Strainer	148
Powafit HD Layflat Hose Couplings	65-66	Stainless Steel Wafer Check Valve	148
Powafit Claw Couplings – A Type	67	PVC Compact & True Union Ball Valves	149
Powafit Claw Couplings – S Type	68	Polypropylene Ball Valves	150-151
Powafit Claw Clamps & Accessories	69	Nylon Check Valve & Screen	152
Powafit Quick Release Couplings	70-80	Air Vacuum Breaker	152
Ground Joint Couplings	81	Barrel Union & Compression Couplings	153
Combination Nipples	82	PVC Check Valves & Foot Valves	153
Steel & Malleable Iron Hose Joiners	82	Brass Spring Check & Swing Check Valves	154
Brass Tank Fittings	82	Wafer Check Valve & Brass Y-Strainer	154
Tank Outlet Rubber Gasket	82	Brass Gate Valves Ezi-Flo & AIP	155
Muff Couplings	83	AIP AS 1628 Tested Gate Valve	155
Flanged Hose Tails & Strainers	83	Bronze Untested Gate Valve	155
Stainless Steel Filters (Drawtubes)	83	Knife Gate Valves	156
Storz Fittings	84-85	Cast Iron Gate Valve	156
Quick Connect Couplings	86-90	Butterfly Valves & Extensions	157
AIP Quick Connect Couplings	86	Shouldered Butterfly Valves & Clamps	158
Ryco Couplings	87-88	Actuated Valves & Accessories	159-163
Jamec Couplings	89-90	Filter Regulators & Lubricators	164-166
Self Store Fittings	90	Float Valves & Accessories	167
Brass Fittings	91-101	Strainers & Foot Valves	168
Plumbing Screwed Brassware	102-104	Brass Hose Cocks & Accessories	169
Legris Fittings & Tubing	105-111	Vacuum Breaker & Dual Check Valve	169
Legris Brass Compression Fittings	105	AIP Thread Tape & Duct Tape	170
Legris Push-In Fittings	106-108	Nozzles & Blow Guns	171-174
Legris Tubing	109-111	Aluminium Nozzles	171
Nylon Fittings	112-122	Washdown Guns & Nozzles	171
Tefen Fittings (Blue)	112-115	Red Nylon Nozzles	172
Nylon Fittings (White)	116-122	Heavy Duty Nozzles	173
Nyglass & Poly Fittings & Risers	123-127	Blow Guns	174
Nyglass & Polypropylene Screwed Fittings	123-126	Clamps	175-192
Polypropylene Layflat Hose Fittings	126	Breeze 62 Series Worm Drive Clamps	175
Polypropylene Threaded Risers	127	Breeze 63 Series Worm Drive Clamps	176
Pipe Fittings	128-135	Breeze 73 Series Worm Drive Clamps	177
Gal Mal Fittings	128-129	Double Ear Clamps	177
Gal Steel Pipe Pieces	130	Powaflex Worm Drive Clamps	178
Gal Steel Fittings	131	Cobra Quick Fit Hose Clamps	179
Black Steel Fittings	132	Super Clamps Standard (Low Carbon)	180
Buttweld Fittings	133-134	Super Clamps Stainless	181
Stainless Steel Screwed Fittings	135	Super Clamp Merchandiser	182
Raynbo Garden Fittings & Accessories	136-139	Worm Drive Clamp Merchandiser	183
Raynbo Plastic Snap-On Fittings	136	Band-It Clamps	184-187
Raynbo Brass Click-On Fittings	137	Double Bolt Clamps	188
Raynbo Tap Timer, Sprinklers, Nozzles	138	4 & 6 Bolt & Spiral Clamps	189
Raynbo Lilac Grey Water Snap-On Fittings	138	Pipe Repair Clamps	190-192
Raynbo Spray Guns	139	Cable Ties	193
		Hose Reels	193-194
		Retractable Hose Reels	193
		AIP Steel Hose Reels	194
		Hose Merchandisers	195-197
		Pressure Gauges	198-199
		Technical Information	200-220

BREEZE WORM DRIVE CLAMPS U.S.A.

62 SERIES

Stainless steel band (perforated) and housing with zinc plated carbon steel screw, 12.7mm band, 8mm slotted hex head screw.

	CLAMP DIAMETER	PART No.	LIST \$/BOX 10	LIST \$/EACH
	MM			
	6-16	BZ3504*	18.40	1.84
	11-20	BZ3506*	19.20	1.92
	11-20	BZ62006	18.40	1.84
	13-23	BZ62008	21.10	2.11
	14-27	BZ62010	21.10	2.11
	17-32	BZ62012	21.10	2.11
	21-38	BZ62016	21.20	2.12
	21-44	BZ62020	22.50	2.25
	27-51	BZ62024	22.80	2.28
	33-57	BZ62028	24.90	2.49
	40-64	BZ62032	27.20	2.72
	46-70	BZ62036	30.00	3.00
	52-76	BZ62040	32.40	3.24
	59-83	BZ62044	32.90	3.29
	65-89	BZ62048	35.50	3.55
	71-95	BZ62052	36.00	3.60
	78-102	BZ62056	36.30	3.63
	84-108	BZ62060	38.00	3.80
	91-114	BZ62064	41.40	4.14
	48-127	BZ62072	47.50	4.75
64-140	BZ62080	54.00	5.40	
79-152	BZ62088	58.30	5.83	
92-165	BZ62096	59.70	5.97	
105-178	BZ62104	68.00	6.80	

* 3504 & 3506 8mm wide band & 6mm hex screw

PRICES DO NOT INCLUDE GST
E&O.E

BREEZE WORM DRIVE CLAMPS U.S.A.

63 SERIES

Full stainless steel marine grade, 12.7mm band (perforated), 8mm hex head screw.

	CLAMP DIAMETER	PART No.	LIST \$/BOX 10	LIST \$/EACH
	MM			
	6-16	BZ3704*	27.20	2.72
	11-20	BZ3706*	27.90	2.79
	11-20	BZ63006	31.30	3.13
	13-23	BZ63008	31.30	3.13
	14-27	BZ63010	31.30	3.13
	17-32	BZ63012	32.70	3.27
	21-38	BZ63016	33.50	3.35
	21-44	BZ63020	35.60	3.56
	27-51	BZ63024	35.60	3.56
	33-57	BZ63028	38.20	3.82
	40-64	BZ63032	39.40	3.94
	46-70	BZ63036	41.70	4.17
	52-76	BZ63040	44.50	4.45
	59-83	BZ63044	46.10	4.61
	65-89	BZ63048	46.10	4.61
	71-95	BZ63052	50.70	5.07
	78-102	BZ63056	52.20	5.22
	84-108	BZ63060	52.70	5.27
	91-114	BZ63064	52.70	5.27
	48-127	BZ63072	59.30	5.93
	64-140	BZ63080	64.40	6.44
	79-152	BZ63088	66.50	6.65
	92-165	BZ63096	70.80	7.08
	105-178	BZ63104	74.30	7.43

* 3704 & 3706 8mm wide band & 6mm hex screw

BREEZE MAKE-A-CLAMP – FULL STAINLESS STEEL

12.7mm wide stainless steel band perforated, 8mm hex head screw.

	CLAMP RANGE MM	PART No.	LIST \$/EACH
	76mm to 760mm	BZ4000	47.08

PRICES DO NOT INCLUDE GST
E&O.E

BREEZE WORM DRIVE CLAMPS U.S.A.

73 SERIES

Full stainless steel marine grade, 13mm non-perforated band, 7mm hex head screw.

	CLAMP DIAMETER MM	PART No.	LIST \$/BOX 10	LIST \$/EACH
	11-20	BZ73006	29.20	2.92
	13-23	BZ73008	29.60	2.96
	14-27	BZ73010	29.60	2.96
	17-32	BZ73012	31.30	3.13
	21-38	BZ73016	32.40	3.24
	21-44	BZ73020	33.50	3.35
	27-51	BZ73024	38.90	3.89
	33-57	BZ73028	38.90	3.89
	40-64	BZ73032	38.90	3.89
	46-70	BZ73036	45.40	4.54
	52-76	BZ73040	45.90	4.59
	59-83	BZ73044	46.40	4.64
	65-89	BZ73048	47.00	4.70
	71-95	BZ73052	49.10	4.91
	78-102	BZ73056	50.20	5.02
	84-108	BZ73060	51.30	5.13
	91-114	BZ73064	51.60	5.16
	103-127	BZ73072	51.80	5.18
	116-140	BZ73080	56.70	5.67
129-152	BZ73088	59.40	5.94	
141-165	BZ73096	75.10	7.51	
154-178	BZ73104	81.00	8.10	

DOUBLE EAR CLAMP – YELLOW DI-CHROMATE COATED

	CLAMP DIAMETER MM	PART No.	BOX QTY	LIST \$/EACH
	5-7	TEC57-100	100	1.22
	7-9	TEC79-100	100	1.22
	9-11	TEC911-100	100	1.22
	11-13	TEC1113-100	100	1.22
	13-15	TEC1315-100	100	1.27
	15-18	TEC1518-100	100	1.40
	17-20	TEC1720-100	100	1.56
	20-23	TEC2023-100	100	1.94
	22-25	TEC2225-100	100	2.00
	25-28	TEC2528-100	100	2.33
	28-31	TEC2831-100	100	2.92
	31-34	TEC3134-100	100	3.13
	34-37	TEC3437-100	100	3.26
	37-40	TEC3740-100	100	3.37
	40-43	TEC4043-100	100	3.56
	43-46	TEC4346-100	100	3.83

PRICES DO NOT INCLUDE GST
E&O.E

WORM DRIVE CLAMPS

300 SERIES

Full stainless steel marine grade 12mm band (perforated), 8mm hex head screw.

	CLAMP DIAMETER MM	PART No.	LIST \$/BOX 10	LIST \$/EACH
		6-16	P304*	27.20
	6-22	P306*	27.90	2.79
	13-23	P308	31.30	3.13
	14-27	P310	31.30	3.13
	14-32	P312	32.70	3.27
	17-38	P316	33.50	3.35
	19-44	P320	35.60	3.56
	25-51	P324	35.60	3.56
	32-57	P328	38.20	3.82
	38-63	P332	39.40	3.94
	44-70	P336	41.70	4.17
	51-76	P340	44.50	4.45
	57-82	P344	46.10	4.61
	63-89	P348	46.10	4.61
	70-95	P352	50.70	5.07
	76-102	P356	52.20	5.22
	82-108	P360	52.70	5.27
	89-114	P364	52.70	5.27
	102-127	P372	59.30	5.93
	114-140	P380	64.40	6.44
	127-157	P388	66.50	6.65
	140-165	P396	70.80	7.08

*P304 and P306: 8mm wide band and 6mm hex head screw.

400 SERIES

Stainless steel band (perforated) with zinc plated carbon steel housing and screw. 12mm band, 8mm slotted hex head screw.

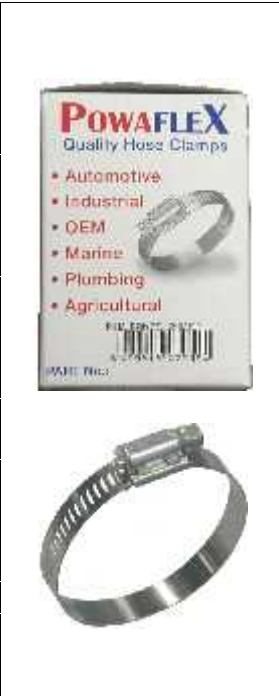
	CLAMP DIAMETER MM	PART No.	LIST \$/BOX 10	LIST \$/EACH
		6-16	P404*	16.60
	6-22	P406*	17.30	1.73
	13-23	P408	19.00	1.90
	14-27	P410	19.00	1.90
	14-32	P412	19.00	1.90
	17-38	P416	19.00	1.90
	19-44	P420	20.30	2.03
	25-51	P424	20.50	2.05
	32-57	P428	22.40	2.24
	38-63	P432	24.50	2.45
	44-70	P436	27.00	2.70
	51-76	P440	29.20	2.92
	57-82	P444	29.60	2.96
	63-89	P448	31.90	3.19
	70-95	P452	32.40	3.24
	76-102	P456	32.70	3.27
	82-108	P460	34.20	3.42
	89-114	P464	37.30	3.73
	102-127	P472	42.80	4.28
	114-140	P480	48.60	4.86
	127-157	P488	52.50	5.25
	140-165	P496	53.80	5.38

*P404 and P406: 8mm wide band and 6mm hex head screw.

PRICES DO NOT INCLUDE GST
E&O.E

COBRA QUICK FIT HOSE CLAMPS

For small hoses and tube. Stainless steel band with low profile closure. Can be reopened if required. Popular in irrigation and spraying applications.

	CLAMP RANGE	BAND WIDTH	PART No.	BOX QTY	LIST \$/100
	MM	MM			
	8.0-9.0	7.0	COB8	100	82.00
	8.5-9.5	7.0	COB85	100	82.00
	9.0-10.0	7.0	COB9	100	82.00
	9.5-10.5	7.0	COB95	100	83.00
	10.0-11.0	7.0	COB10	100	83.00
	10.5-11.5	7.0	COB105	100	84.00
	11.0-12.0	7.0	COB11	100	84.00
	11.5-12.5	7.0	COB115	100	85.00
	12.0-13.5	8.0	COB12	100	86.00
	12.5-14.0	8.0	COB125	100	88.00
	13.5-15.0	8.0	COB135	100	88.00
	14.5-16.0	8.0	COB145	100	89.00
	15.5-17.0	8.0	COB155	100	89.00
	16.5-18.0	8.0	COB165	100	91.00
	17.5-19.0	8.0	COB175	100	91.00
	18.5-20.0	8.0	COB185	100	94.00
	19.5-21.0	8.0	COB195	100	94.00
	20.5-22.0	8.0	COB205	100	98.00
	21.5-23.0	8.0	COB215	100	98.00
	22.5-24.0	8.0	COB225	100	100.00
	23.5-25.0	8.0	COB235	100	100.00
	24.5-26.0	8.0	COB245	100	102.00
	25.5-27.0	8.0	COB255	100	104.00
	26.5-28.0	8.0	COB265	100	105.00
	27.5-29.0	8.0	COB275	100	106.00
	28.5-30.0	8.0	COB285	100	108.00
	29.5-31.0	8.0	COB295	100	114.00
	30.5-32.0	8.0	COB305	100	128.00
	34.0-36.0	9.0	COB34	100	160.00
	36.0-38.0	9.0	COB36	100	177.00

COBRA HAND TOOL

	PART No.	PACK QTY	LIST \$/EACH
	CCHT		1

PRICES DO NOT INCLUDE GST
E&O.E

SUPER CLAMPS



CLAMP RANGE MM	PART No.	BOX QTY	LIST \$/EACH
17-19	SC19	25	2.35
20-22	SC22	25	2.35
23-25	SC25	25	2.42
26-28	SC28	25	2.44
29-31	SC31	25	3.11
32-35	SC35	25	3.11
36-39	SC39	25	3.18
40-43	SC43	25	3.30
44-47	SC47	25	5.49
48-51	SC51	25	5.59
52-55	SC55	25	5.68
56-59	SC59	25	5.73
60-63	SC63	25	6.00
64-67	SC67	25	6.09
68-73	SC73	25	7.90
74-79	SC79	25	7.93
80-85	SC85	25	8.18
86-91	SC91	25	8.32
92-97	SC97	25	8.46
98-103	SC103	25	8.59
104-112	SC112	25	8.62
113-121	SC121	25	10.01
122-130	SC130	25	10.03
131-139	SC139	10	13.17
140-148	SC148	10	13.40
149-161	SC161	10	14.05
162-174	SC174	10	14.51
175-187	SC187	10	14.80
188-200	SC200	10	15.69
201-213	SC213	10	16.09
214-226	SC226	10	16.43
227-239	SC239	10	16.75
240-252	SC252	10	17.09

PRICES DO NOT INCLUDE GST
E&O.E

STAINLESS STEEL SUPER CLAMPS

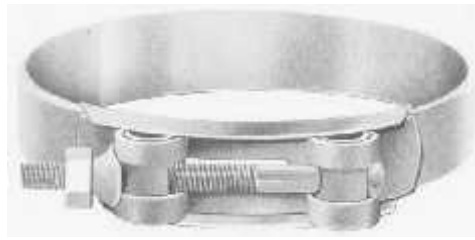

CLAMP RANGE MM	PART No.	BOX QTY	LIST \$/EACH
17-19	SSSC19	25	6.81
20-22	SSSC22	25	7.10
23-25	SSSC25	25	7.10
26-28	SSSC28	25	7.32
29-31	SSSC31	25	8.12
32-35	SSSC35	25	8.46
36-39	SSSC39	25	8.69
40-43	SSSC43	25	8.99
44-47	SSSC47	25	14.05
48-51	SSSC51	25	14.32
52-55	SSSC55	25	15.06
56-59	SSSC59	25	15.36
60-63	SSSC63	25	16.21
64-67	SSSC67	25	16.50
68-73	SSSC73	25	19.40
74-79	SSSC79	25	19.78
80-85	SSSC85	25	19.99
86-91	SSSC91	25	20.27
92-97	SSSC97	25	20.43
98-103	SSSC103	25	20.69
104-112	SSSC112	25	21.00
113-121	SSSC121	25	21.29
122-130	SSSC130	25	21.56
131-139	SSSC139	10	29.69
140-148	SSSC148	10	30.70
149-161	SSSC161	10	30.98
162-174	SSSC174	10	32.44
175-187	SSSC187	10	32.73
188-200	SSSC200	10	33.61
201-213	SSSC213	10	33.75
214-226	SSSC226	10	33.75
227-239	SSSC239	10	35.50
240-252	SSSC252	10	35.76

PRICES DO NOT INCLUDE GST
E&O.E

AIP SUPER CLAMP MERCHANDISER

Made from sheet metal, powder coated, with mild steel hooks. Displays 26 of the most popular sizes of super clamps. The clamp size and part number are displayed under each hook for quick and easy selection. Not free standing (attach securely to wall).

CLAMP RANGE MM	PART No.	MAXIMUM CLAMP QUANTITY PER HOOK
17-19	SC19	7
20-22	SC22	7
23-25	SC25	7
26-28	SC28	7
29-31	SC31	7
32-35	SC35	7
36-39	SC39	7
40-43	SC43	7
44-47	SC47	7
48-51	SC51	7
52-55	SC55	7
56-59	SC59	7
60-63	SC63	7
64-67	SC67	7
68-73	SC73	7
74-79	SC79	7
80-85	SC85	7
86-91	SC91	7
92-97	SC97	7
98-103	SC103	7
104-112	SC112	7
113-121	SC121	7
122-130	SC130	7
131-139	SC139	6
140-148	SC148	6
149-161	SC161	6

MERCHANDISER PART No.: AIPSCM

LIST PRICE MERCHANDISER ONLY: \$275.00

(For clamp prices, refer to page 180 less your discount)

PRICES DO NOT INCLUDE GST
E&O.E

AIP HOSE CLAMP MERCHANDISER

Made from sheet metal, powder coated with mild steel hooks. Displays 20 of the most popular sizes of worm drive clamps. The clamp size range and part number are displayed under each hook for quick and easy selection. Two detachable steel shelves are included to accommodate replacement stock. Not free standing (attach securely to wall). To suit worm drive clamps 62, 63 and 73 series.

CLAMP RANGE MM	PART No.	MAXIMUM CLAMP QUANTITY PER HOOK
6-16 (x 8mm band)	04	10
11-20 (x 8mm band)	06	10
11-20 (x 12.7mm band)	06	10
13-23 (x 12.7mm band)	08	10
14-27 (x 12.7mm band)	10	10
17-32 (x 12.7mm band)	12	10
21-38 (x 12.7mm band)	16	10
21-44 (x 12.7mm band)	20	10
27-51 (x 12.7mm band)	24	10
33-57 (x 12.7mm band)	28	10
40-64 (x 12.7mm band)	32	10
46-70 (x 12.7mm band)	36	10
52-76 (x 12.7mm band)	40	10
59-83 (x 12.7mm band)	44	10
65-89 (x 12.7mm band)	48	10
71-95 (x 12.7mm band)	52	10
78-102 (x 12.7mm band)	56	10
84-108 (x 12.7mm band)	60	10
91-114 (x 12.7mm band)	64	10
48-127 (x 12.7mm band)	72	10

MERCHANDISER
PART No.: AIPHCM

Dimensions: 570mm x 1170mm.

List price - merchandiser only: \$348.00

(For clamp prices refer to pages 175-177 less your discount).

PRICES DO NOT INCLUDE GST
E&O.E

BAND-IT CLAMPING SYSTEM



BAND-IT BAND

Type 201 stainless steel.

	WIDTH INCH	WIDTH MM	ROLL LENGTH MTR	PART No.	LIST \$/ROLL
	1/4	6.4	30.5	BIC202	142.38
	3/8	9.5	30.5	BIC203	167.63
	1/2	12.7	30.5	BIC204	230.95
	5/8	15.8	30.5	BIC205	269.22
	3/4	19.1	30.5	BIC206	330.49

BAND-IT BUCKLES

	WIDTH INCH	WIDTH MM	BOX QTY	PART No.	LIST \$/BOX
	1/4	6.4	100	BIC252	104.63
	3/8	9.5	100	BIC253	115.34
	1/2	12.7	100	BIC254	167.63
	5/8	15.8	100	BIC255	188.84
	3/4	19.1	100	BIC256	241.40

BAND-IT TOOL

Tensioning capability of over 2,400 lbs, with a built-in cutter. The Band-It tool is used to apply Band-It bands and buckles, strapping and free-end clamps.

	PART No.	LIST \$/EACH
	BIC001	654.10

PRICES DO NOT INCLUDE GST
E&O.E

BAND-IT

GIANT BAND

Type 201 stainless steel.

	WIDTH INCH	WIDTH MM	ROLL LENGTH MTR	PART No.	LIST \$/ROLL
	3/4	19.1	30.5	BIG430	721.98
	1	25.4	30.5	BIG431	845.20
	1 1/4	32	30.5	BIG432	1046.17

GIANT BUCKLES

	WIDTH INCH	WIDTH MM	BOX QTY	PART No.	LIST \$/BOX
	3/4	19.1	25	BIG440	230.58
	1	25.4	25	BIG441	282.40
	1 1/4	32	25	BIG442	356.84

GIANT BAND-IT TOOL

Used to apply heavy duty giant clamps. Designed to pull up to 6,000 lbs.

	PART No.	LIST \$/EACH
	BIG402	3148.85

Jr ADAPTOR

For use with BIC001 Band-It tool to apply Band-It Jr preformed clamps.

	PART No.	LIST \$/EACH
	BIJ001	619.03

PRICES DO NOT INCLUDE GST
E&O.E

BAND-IT

Jr PREFORMED CLAMPS

Type 201 stainless steel, vibration resistant, requires no hammering or crimping, automatically locks in one lever movement.

CLAMP I.D. MM	BOX QTY	PART No.	LIST \$/BOX
6.4MM BAND x 0.51MM THICK			
20.6	100	BIJS240	419.95
25.4	100	BIJS242	433.23
34.9	100	BIJS241	430.34
38.1	100	BIJS252	430.13
50.8	100	BIJS253	472.08
69.9	100	BIJS256	608.21
88.9	100	BIJS257	628.90
9.5MM BAND x 0.64MM THICK			
20.6	100	BIJS201	409.29
25.4	100	BIJS243	482.79
34.9	100	BIJS202	479.01
50.8	100	BIJS245	503.63
63.5	100	BIJS221	655.04
76.2	100	BIJS246	650.11
101.6	100	BIJS248	839.74
12.7MM BAND x 0.76MM THICK			
31.8	100	BIJS204	619.19
44.5	100	BIJS236	838.37
69.9	100	BIJS230	976.24
76.2	100	BIJS234	1048.85
88.9	100	BIJS247	1294.65
101.6	100	BIJS249	1321.53
15.9MM BAND x 0.76MM THICK			
38.1	100	BIJS205	784.30
44.5	100	BIJS206	859.90
50.8	100	BIJS207	934.24
57.2	100	BIJS208	986.74
63.5	100	BIJS209	1027.58
19.1MM BAND x 0.76MM THICK			
50.8	100	BIJS227	1213.70
69.9	50	BIJS210	652.37
76.2	50	BIJS211	687.23
88.9	50	BIJS212	734.84
101.6	25	BIJS213	430.34
114.3	25	BIJS214	457.64
127.0	25	BIJS215	488.41
152.4	25	BIJS216	576.61

ULTRA-LOK PREFORMED CLAMPS

CLAMP I.D. MM	BOX QTY	PART No.	LIST \$/BOX
12.7MM BAND x 0.76MM THICK			
38.1	100	BIUL279	826.00
50.8	100	BIUL283	837.00
69.9	100	BIUL286	864.00
101.6	100	BIUL291	1140.00
19.1MM BAND x 0.76MM THICK			
50.8	100	BIUL227	1047.00
69.9	50	BIUL210	540.00
76.2	50	BIUL211	582.00
88.9	50	BIUL212	622.00
101.6	25	BIUL213	356.25
114.3	25	BIUL214	398.00
127	25	BIUL215	479.00
139.7	25	BIUL270	470.00
152.4	25	BIUL216	520.00
165.1	25	BIUL217	555.00
177.8	25	BIUL218	575.00
203.2	25	BIUL219	950.00
228.6	10	BIUL228	450.00

PRICES DO NOT INCLUDE GST
E&O.E

BAND-IT

BAND-IT CENTRE PUNCH CLAMPS

Type 201 stainless steel locked with a standard conical punch to ensure a strong lock.

	CLAMP I.D. INCH	CLAMP I.D. MM	BAND WIDTH MM	BOX QTY	PART No.	LIST \$/BOX
	1 3/16	20	9.5	100	BICP3S	335.90
	1 3/8	35	9.5	100	BICP311S	372.60
	1	25	16	100	BICP4S	497.54
	1 1/4	32	16	100	BICP5S	472.45
	1 1/2	38	16	100	BICP6S	592.15
	1 3/4	44	16	100	BICP7S	514.45
	2	51	16	100	BICP8S	545.84
	2 1/4	57	16	100	BICP9S	591.73
	2 1/2	64	16	50	BICP10S	331.75
	2 3/4	70	16	50	BICP11S	391.60
	3	76	16	50	BICP12S	418.90
	3 1/2	89	16	50	BICP14S	450.50
	4	102	16	25	BICP16S	268.43
	4 1/2	114	16	25	BICP18S	277.41
	5	127	16	25	BICP20S	300.67
	6	152	16	25	BICP24S	337.00
7	178	16	25	BICP28S	397.90	
8	203	16	25	BICP32S	440.58	

BAND-IT CENTRE PUNCH TOOL



	PART No.	LIST \$/EACH
	BIS38	293.48

PRICES DO NOT INCLUDE GST
E&O.E

HOSE CLAMPS

DOUBLE BOLT CLAMPS – WITH CLAW

Plated finish carbon steel – AS 2074.

	SIZE INCH	SIZE RANGE MM	PART No.	BOX QTY	LIST \$/EACH
	½	22-29	DBCC29	50	11.50
	¾	28-34	DBCC34	50	12.80
	1	35-40	DBCC40	50	13.45
	1¼	42-47	DBCC47	15	14.20
	1½	50-54	DBCC54	15	28.70
	2	63-67	DBCC67	15	35.80
	3	94-115	DBCC115	1	POA

DOUBLE BOLT CLAMPS – WITH TWO SADDLES

	SIZE RANGE MM	PART No.	LIST \$/EACH
	22-29	DBC29	9.18
	28-34	DBC34	9.45
	35-40	DBC40	11.15
	42-47	DBC47	18.70
	50-54	DBC54	19.80
	63-67	DBC67	28.95
	94-115	DBC115	58.10
	88.9-96.8	DBC400	25.59
	96.0-103.2	DBC431	31.59
	102.4-108.7	DBC463	27.81
	108.0-125.4	DBC525	35.37
	114.3-133.4	DBC550	37.14
	130.2-144.5	DBC600	39.60
	144.5-150.8	DBC639	45.39
	150.8-165.1	DBC675	43.38
	165.1-192.1	DBC769	48.24
	195.3-208.0	DBC818	69.81
	209.6-225.4	DBC875	67.68
	227.0-250.8	DBC988	82.32
252.4-288.9	DBC1125	141.51	
284.2-330.2	DBC1275	173.10	
309.6-355.6	DBC1360	258.99	
335.0-381.0	DBC1450	258.99	
382.6-444.5	DBC1700	258.99	

Note: check hose O.D. accurately to ensure correct clamp/fitting retention.

PRICES DO NOT INCLUDE GST
E&O.E

4-BOLT CLAMP WITH GRIPPING FINGERS (MALLEABLE IRON)

	HOSE I.D. MM	SIZE RANGE MM	PART No.	LIST \$/EACH
	25	35.7-39.7	4BOLTCL25397	31.92
	25	38.9-43.7	4BOLTCL25437	32.36
	25	42.9-54.0	4BOLTCL25540	32.69
	32	45.2-53.2	4BOLTCL32532	57.89
	32	54.0-60.3	4BOLTCL32603	44.39
	40	50.8-54.0	4BOLTCL40540	51.37
	40	52.4-57.2	4BOLTCL40572	52.27
	40	55.6-60.3	4BOLTCL40603	48.96
	40	60.3-65.1	4BOLTCL40651	46.04
	40	65.1-69.9	4BOLTCL40699	51.98
	50	59.5-64.3	4BOLTCL50643	68.33
	50	63.5-69.9	4BOLTCL50699	66.67
	50	69.9-77.8	4BOLTCL50778	58.82
	50	63.2-87.3	4BOLTCL50873	112.86
	65	78.6-87.3	4BOLTCL65873	121.79
	65	88.9-100.0	4BOLTCL65100	130.75
	75	88.9-100.0	4BOLTCL75100	136.62
	75	101.6-106.4	4BOLTCL751064	225.72
75	103.2-112.7	4BOLTCL751127	214.48	
75	106.4-114.3	4BOLTCL751143	207.90	

6-BOLT (THREE PIECE) CLAMP WITH GRIPPING FINGERS

	HOSE I.D. MM	SIZE RANGE MM	PART No.	LIST \$/EACH
	75	108.0-122.2	6BOLTCL751222	334.14
	100	117.5-127.0	6BOLTCL100127	346.50
	100	123.8-133.4	6BOLTCL1001334	502.44
	100	133.4-142.1	6BOLTCL1001421	606.39
	100	140.5-150.8	6BOLTCL1001508	574.20
	150	174.6-187.3	6BOLTCL1501873	606.39
	150	190.5-203.2	6BOLTCL1502032	606.39

SPIRAL CLAMPS

To suit corrugated hose covers. Available in both types to suit either clockwise or counter clockwise wound hose.

	TO SUIT CLOCKWISE WOUND HOSE (R/H)				TO SUIT COUNTER CLOCKWISE WOUND HOSE (L/H)			
	HOSE I.D. INCH	HOSE I.D. MM	PART No.	LIST \$/EACH	HOSE I.D. INCH	HOSE I.D. MM	PART No.	LIST \$/EACH
	1½	38	SCR38	12.30	1½	38	SCL38	12.30
	2	50	SCR50	15.27	2	50	SCL50	15.27
	2½	65	SCR65	17.46	2½	65	SCL65	17.46
	3	75	SCR75	18.42	3	75	SCL75	18.42
	4	100	SCR100	22.26	4	100	SCL100	22.26
	5	125	SCR125	29.13	5	125	SCL125	29.13
	6	150	SCR150	33.39	6	150	SCL150	33.39
8	200	SCR200	38.78	8	200	SCL200	38.78	

Note: check hose O.D. accurately to ensure correct clamp/fitting retention.

PRICES DO NOT INCLUDE GST
E&O.E



ALL STAINLESS STEEL PERMANENT REPAIR CLAMPS



FULL CIRCUMFERENCE CLAMPS

	NOMINAL PIPE SIZE (MM)	OUTSIDE DIAMETER RANGE (MM)	CLAMP LENGTH (MM)	PART No.	LIST \$/EACH
50		45-55	150	RCR1022006	80.25
		59-67	150	RCR1023806	80.25
		69-76	150	RCR1028806	85.43
75		75-83	150	RCR1030006	90.60
		75-83	200	RCR1030008	117.89
		87-93	150	RCR1035006	90.60
		87-93	200	RCR1035008	117.89
		95-104	200	RCR1037508	103.54
100		104-113	200	RCR1044008	111.30
		113-120	200	RCR1045008	116.48
		121-130	200	RCR1048008	116.48
		121-130	300	RCR1048012	192.12
150		150-161	200	RCR1060008	147.50
		155-165	200	RCR1062908	147.50
		167-176	200	RCR1066308	147.50
		174-183	200	RCR1069008	147.50
		174-183	300	RCR1069012	234.20
200		196-205	200	RCR1079008	176.02
		218-228	200	RCR1086308	181.19
		229-238	200	RCR1090008	181.19
		229-238	300	RCR1090012	295.25
		236-245	200	RCR1090508	181.19
225		248-257	300	RCR1100012	323.57
		255-265	300	RCR1104012	323.57
250		271-281	300	RCR1107512	362.40
		281-290	300	RCR1111012	362.40
300		322-330	300	RCR1127512	401.23
		322-330	400	RCR1127516	491.82
		331-341	400	RCR1132016	491.82
		342-355	400	RCR1137016	517.70
		356-366	400	RCR1140016	517.70
375		390-410	400	RCR239041016	1175.64
		390-410	500	RCR239041024	1763.43
		410-435	400	RCR241043516	1222.65
		410-435	500	RCR241043524	1833.99
400		440-465	400	RCR244046516	1222.65
		440-465	500	RCR244046524	1833.99
450		490-515	400	RCR249051516	1269.69
		490-515	500	RCR249051524	1904.52
500		560-585	400	RCR256058516	1410.75
		560-585	500	RCR256058524	2116.14
525		570-600	400	RCR257060016	1434.27
600		650-680	400	RCR265068016	1822.23
		650-680	500	RCR265068024	2733.33



NB: customised BSP threaded sockets/take offs available – POA.

PRICES DO NOT INCLUDE GST
E&O.E

HALF CLAMPS (PART CIRCUMFERENCE SEAL)

	NOMINAL PIPE SIZE		PIPE OUTSIDE DIAMETER		CLAMP LENGTH MM	PART No.	LIST \$/EACH
	MM	INCHES	MM	INCHES			
	15	1/2	21.3	0.84	75	RCFC08403	16.83
	15	1/2	21.3	0.84	150	RCFC08406	33.65
	20	3/4	26.7	1.05	75	RCFC10503	17.49
	20	3/4	26.7	1.05	150	RCFC10506	34.95
	25	1	33.4	1.32	75	RCFC13203	18.12
	25	1	33.4	1.32	150	RCFC13206	36.23
	32	1 1/4	42.2	1.66	75	RCFC16003	18.79
	32	1 1/4	42.2	1.66	150	RCFC16006	37.53
	40	1 1/2	48.3	1.90	75	RCFC19003	19.42
	40	1 1/2	48.3	1.90	150	RCFC19006	38.83
	50	2	60.3	2.38	75	RCFC23803	21.44
	50	2	60.3	2.38	150	RCFC23806	42.71
	65	2 1/2	76.0	3.00	75	RCFC30003	25.26
	65	2 1/2	76.0	3.00	150	RCFC30006	50.48
	80	3	89.0	3.50	75	RCFC35003	29.77
	80	3	89.0	3.50	150	RCFC35006	59.53
100	4	114.0	4.50	75	RCFC45003	35.60	
100	4	114.0	4.50	150	RCFC45006	70.59	

JUNIOR COUPLING (FULL CIRCUMFERENCE SEAL)

TO SUIT GALVANISED PIPE							
	NOMINAL PIPE SIZE		PIPE OUTSIDE DIAMETER		CLAMP LENGTH MM	PART No.	LIST \$/EACH
	MM	INCHES	MM	INCHES			
	15	1/2	21.3	0.84	75	RCFW15mmG3	25.90
	15	1/2	21.3	0.84	150	RCFW15mmG6	51.77
	20	3/4	26.7	1.05	75	RCFW20mmG3	27.84
	20	3/4	26.7	1.05	150	RCFW20mmG6	55.65
	25	1	33.4	1.32	75	RCFW25mmG3	29.77
	25	1	33.4	1.32	150	RCFW25mmG6	59.53
	32	1 1/4	42.2	1.66	75	RCFW32mmG3	32.36
	32	1 1/4	42.2	1.66	150	RCFW32mmG6	64.71

TO SUIT COPPER PIPE							
	NOMINAL PIPE SIZE		PIPE OUTSIDE DIAMETER		CLAMP LENGTH MM	PART No.	LIST \$/EACH
	MM	INCHES	MM	INCHES			
	15	1/2	12.7	1/2	75	RCFW15mmC3	25.26
	15	1/2	12.7	1/2	150	RCFW15mmC6	50.48
	20	3/4	19.05	3/4	75	RCFW20mmC3	25.88
	20	3/4	19.05	3/4	150	RCFW20mmC6	51.77
	25	1	25.4	1	75	RCFW25mmC3	27.84
	25	1	25.4	1	150	RCFW25mmC6	55.65
	32	1 1/4	31.75	1 1/4	75	RCFW32mmC3	29.77
	32	1 1/4	31.75	1 1/4	150	RCFW32mmC6	59.53
40	1 1/2	38.1	1 1/2	75	RCFW40mmC3	32.36	
40	1 1/2	38.1	1 1/2	150	RCFW40mmC6	64.71	

PRICES DO NOT INCLUDE GST
E&O.E



ARMOUR PLATES ARE VULCANISED – THEY CAN NEVER FALL OUT



THE ARMOUR PLATE INSERTED INTO THE GASKET IS A CRUCIAL ELEMENT IN THE PERFORMANCE OF A REPAIR CLAMP, AS IT PROVIDES THE FULL CIRCUMFERENCE SEALING CAPABILITY OF THE REPAIR CLAMP.

LOCKING WASHER PLATE: T316 stainless steel. Locks into position for easy tightening of nuts.

BOLT RECEIVERS: T316 stainless steel, MIG welded to receiver bar and fully passivated.* Leading edge is rounded to permit locking washer plate to slide into position easily.

SHELL: T316 stainless steel.

BOLTS: T316 stainless steel, thread rolled for strength. Teflon** coated to prevent galling. Bolts are MIG welded to receiver bar and are fully passivated.*

NUTS: T316 stainless steel.

RECEIVER BARS: T316 stainless steel, TIG welded to shell to form a strong fusion, and fully passivated.*

GASKET: Made to ASTM D 2240 the rubber is specially formulated for water service and has antioxidant/antiozonant agents to increase shelf life.

ARMOUR: T316 stainless steel, heavy gauge, vulcanised into gasket to provide a perfect fit and to prevent it from ever falling out.



Wrap clamp around pipe. Bring together using locking washer plate.



Lock in place. Squeeze the lugs together and spin the nuts down.



Tighten the nuts evenly with a wrench – no rotating is necessary.



NYLON CABLE TIES

Black weather resistant nylon 6/6 material.

	PART No.	SIZE	QTY PER PACK	LIST \$/PACK
	CT10025	100 x 2.5	100	2.18
	CT14232	142 x 3.2	100	4.49
	CT19048	190 x 4.8	100	6.45
	CT28048	280 x 4.8	100	10.92
	CT36848	368 x 4.8	100	15.92
	CT38076	380 x 7.6	100	22.55
	CT43248	432 x 4.8	100	22.85
	CT55080	550 x 8.0	100	67.87
	CT550130	550 x 13.0	100	84.82
	CT76290	762 x 9.0	100	88.80
	CT116890	1168 x 9.0	100	239.50

RETRACTABLE HOSE REELS



58.0201



58.2671



58.0212

APPLICATION	PART No.	HOSE I.D.	HOSE LENGTH	W.P. PSI	HOSE TYPE	INLET SIZE	HOSE COLOUR	CASE COLOUR	LIST \$/EACH
Air	58.0201	10mm (3/8")	20mtr	300	PVC	1/4" BSP	RED	BLACK	358.05
Air	58.2671	8mm (5/16")	8mtr	300	PVC	1/4" BSP	RED	BLACK	238.70
Water/Garden	58.0212	12mm (1/2")	20mtr	80	PVC	1/4" BSP	GREEN	GREEN	314.65

Other sizes and specifications available – POA.

PRICES DO NOT INCLUDE GST
E&O.E

AIP STEEL HOSE REELS

Quality heavy duty steel hose reels – blue powder coated finish

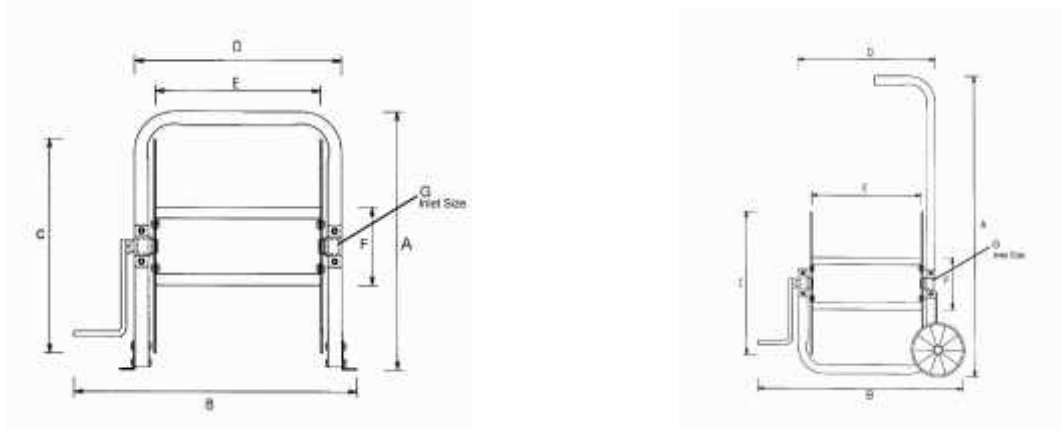

SPECIFICATIONS

PART No.	HOSE MM	LENGTH MTR	A	B	C	D	E	F	G	COLOUR	LIST \$/EACH
AIPSR1230	12	30	395	395	310	285	210	140	1/2" BSP	Space Blue	188.00
AIPSR1250	12	50	395	495	310	385	310	140	1/2" BSP	Space Blue	210.00
AIPSR1840	18	40	460	495	375	385	310	140	3/4" BSP	Space Blue	290.00
AIPLR1860	18	60	460	585	375	485	410	140	3/4" BSP	Space Blue	290.00
AIPSM1250	12	50	850	495	310	385	310	140	1/2" BSP	Space Blue	290.00
AIPSM1840	18	40	850	495	375	385	310	140	3/4" BSP	Space Blue	389.00
AIPLM1860	18	60	850	595	375	485	410	140	3/4" BSP	Space Blue	389.00
AIPELS18100	18	100	725	495	650	385	310	140	3/4" BSP	Space Blue	435.00
AIPELS18200	18	200	725	595	650	485	410	140	3/4" BSP	Space Blue	527.00
AIPELM18100	18	100	950	495	650	385	310	140	3/4" BSP	Space Blue	620.00
AIPELM18200	18	200	950	595	650	485	410	140	3/4" BSP	Space Blue	654.00

Packed flat in cardboard cartons for cost effective freight and warehousing and ready for assembly.



SR = Small Reel
 LR = Large Reel
 SM = Small Mobile Reel
 LM = Large Mobile Reel
 ELS = Extra Large Stationary Reel
 ELM = Extra Large Mobile Reel



Please note:  Brass SP3 swivel tailpieces available to suit (please specify size required) - P.O.A.

PRICES DO NOT INCLUDE GST
 E&O.E

POWAFLEX

INDUSTRIAL HOSE MERCHANDISER

For convenient, neat and tidy hose storage and dispensing. Steel frame incorporating steel feet for securing to the floor. Powder coated, easy to assemble, packed in flat cardboard cartons for easy storage and transportation.

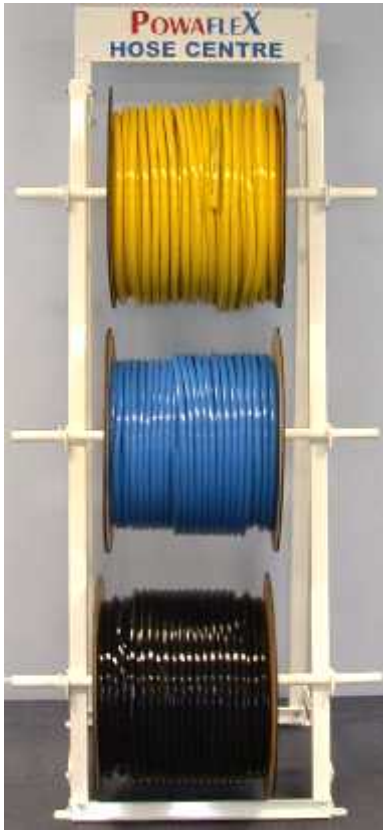

Part No.: AIPMS

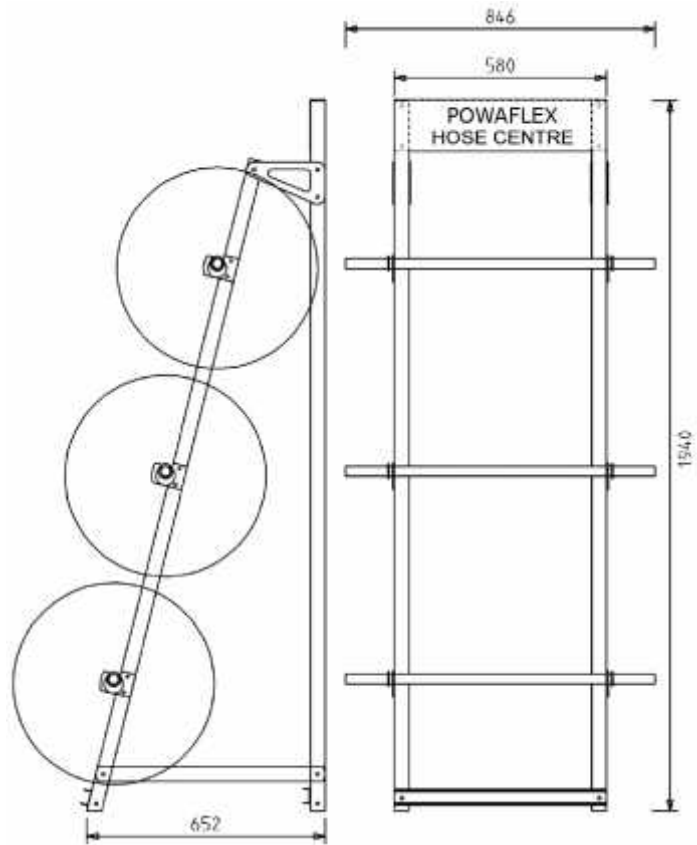

List price \$645.00 (stand only)

Hose types and sizes available to suit the "Powaflex Hose Centre" merchandiser

PRODUCT	CODE	6mm	8mm	10mm	12mm	16mm	19mm	25mm
PVC								
Safety Yellow	PFSY	300 PFSY6300WS	300 PFSY8300WS	200 PFSY10200WS	200 PFSY12200WS	-	100 PFSY19100WS	60 PFSY2560WS
TPR	PFTPR	300 PFTPR6300WS	300 PFTPR8300WS	200 PFTPR10200WS	200 PFTPR12200WS	100 PFTPR16100WS	100 PFTPR19100WS	60 PFTPR2560WS
Tradeflex	TF	300 TF6300WS	300 TF8300WS	200 TF10200WS	200 TF12200WS	-	100 TF19100WS	-
Chemflex	CFBK	300 CFBK6300WS	300 CFBK8300WS	200 CFBK10200WS	200 CFBK12200WS	-	100 CFBK19100WS	60 CFBK2560WS
Hi-Spray	HSAS	300 HSAS6300WS	300 HSAS8300WS	200 HSAS10200WS	200 HSAS12200WS	-	100 HSAS19100WS	60 HSAS2560WS
White Washdown	PFGW	-	-	-	200 PFGW12200WS	-	100 PFGW19100WS	60 PFGW2560WS
Firereel	PFRH	-	-	-	-	-	100 PFRH19100WS	-
Drum Pump	FDPH	-	-	-	-	-	100 FDPH19100WS	60 FDPH2560WS
Divers Air	DH	-	300 DH8300WS	200 DH10200WS	-	-	-	-
Gardenflex	GFGH	-	-	-	200 GFGH12200WS	-	100 GFGH19100WS	60 GFGH2560WS
Allrounder II	ARGH	-	-	-	200 ARGH12200WS	-	100 ARGH19100WS	60 ARGH2560WS
Greenflex Ag-Ind	GFAI	-	-	-	200 GFAI12200WS	-	100 GFAI19100WS	60 GFAI2560WS
White Drag Hose	PFDH	-	-	-	200 PFDH12200WS	-	100 PFDH19100WS	60 PFDH2560WS
RUBBER								
Multi-Purpose	PFMP	200 PFMP6200WS	200 PFMP8200WS	200 PFMP10200WS	160 PFMP12160WS	100 PFMP16100WS	80 PFMP1980WS	60 PFMP2560WS

PRICES DO NOT INCLUDE GST
E&O.E

CVT (CLEAR VINYL TUBING) MERCHANDISER

For convenient, neat and tidy storage and dispensing. Steel frame incorporating steel feet for securing to the floor. Powder coated, easy to assemble, packed in flat cardboard cartons for easy storage and transportation.



Part No.: AIPCVTMS

List price \$495.00 (stand only)

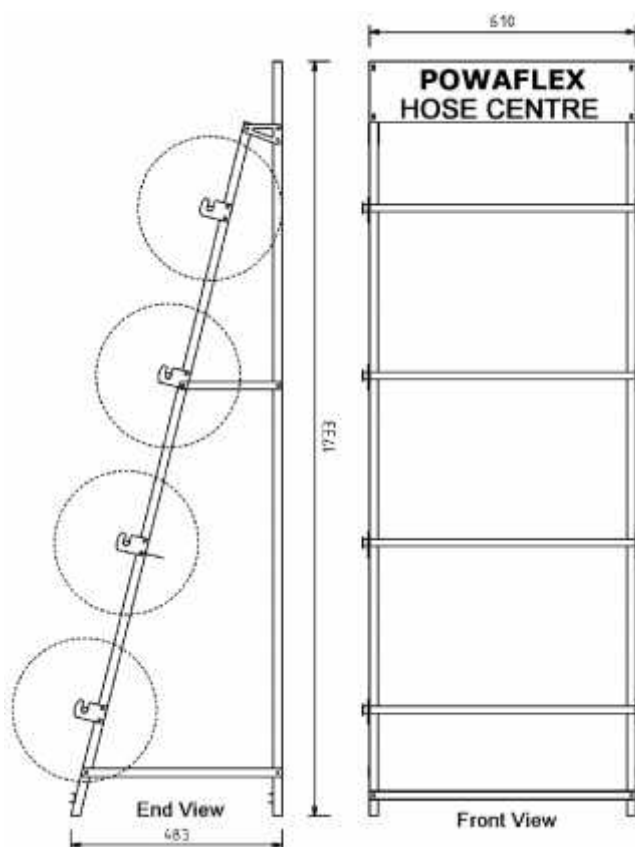

CVT SIZES AVAILABLE ON PLASTIC SPOOLS:

PART No.	I.D. MM	O.D. MM	SPOOL LENGTHS MTR
CVTSP3120	3.0	5.0	120
CVTSP5120	5.0	8.0	120
CVTSP6100	6.0	9.0	100
CVTSP880	8.0	11.0	80
CVTSP1060	10.0	13.0	60
CVTSP1250	12.0	15.0	50
CVTSP1640	16.0	19.0	40
CVTSP2030	20.0	24.0	30
CVTSP2520	25.0	30.0	20

(Sizes 32mm, 40mm and 50mm available in 30mtr coils)

PRICES DO NOT INCLUDE GST
E&O.E

POWAFLEX

PVC LAYFLAT HOSE MERCHANDISER

For the convenient, neat and tidy storage and dispensing of layflat hose. Steel frame, powder coated, flat packed in cardboard cartons ready for assembly.

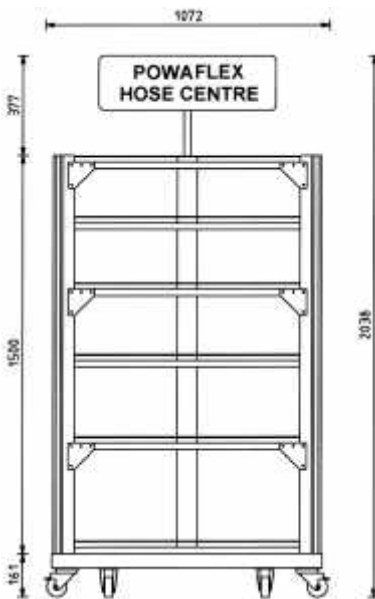

AIPLFS (basic stand only)
LIST \$2500.00

AIPLFSMB (mobile base only)
LIST \$3200.00

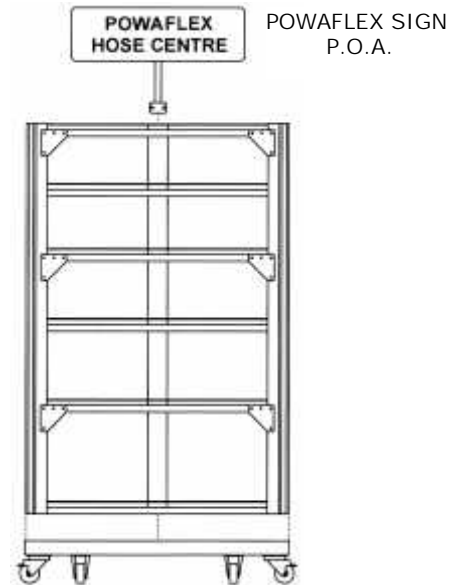

Suitable for sizes 25mm, 32mm, 38mm, 51mm, 63mm, 76mm and 102mm.

PRICES DO NOT INCLUDE GST
E&O.E

AIP PRESSURE GAUGES

63MM DIAL FACE LIQUID FILLED PRESSURE GAUGE
 STAINLESS STEEL CASE, LOWER MOUNT, 1/4" BSP/T, DUAL SCALE PSI /KPA

	PRESSURE RANGE PSI	PART No.	LIST \$/EACH
	0-15	PG25GLM15	41.00
	0-30	PG25GLM30	38.45
	0-60	PG25GLM60	38.45
	0-100	PG25GLM100	38.45
	0-160	PG25GLM160	38.45
	0-230	PG25GLM230	38.45
	0-300	PG25GLM300	38.45
	0-600	PG25GLM600	38.45
	0-1000	PG25GLM1000	40.45
	0-2000	PG25GLM2000	40.45
	0-3000	PG25GLM3000	40.45
	0-3500	PG25GLM3500	45.20
	0-4000	PG25GLM4000	45.20
	0-5000	PG25GLM5000	45.20
	0-8000	PG25GLM8000	54.22
0-10000	PG25GLM10000	54.22	

63MM DIAL FACE LIQUID FILLED PRESSURE GAUGE
 STAINLESS STEEL CASE, BACK MOUNT, 1/4" BSP/T, DUAL SCALE PSI /KPA

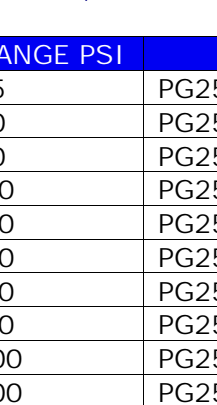
	PRESSURE RANGE PSI	PART No.	LIST \$/EACH
	0-30	PG25GBM30	56.32
	0-60	PG25GBM60	56.32
	0-100	PG25GBM100	56.32
	0-160	PG25GBM160	56.32
	0-200	PG25GBM200	56.32
	0-400	PG25GBM400	56.32
	0-600	PG25GBM600	56.32
	0-1000	PG25GBM1000	56.32

50MM DIAL FACE LIQUID FILLED PRESSURE GAUGE
 STAINLESS STEEL CASE, LOWER MOUNT, 1/4" BSP/T, DUAL SCALE PSI /KPA

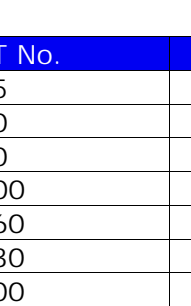
	PRESSURE RANGE PSI	PART No.	LIST \$/EACH
	0-30	PG2GLM30	35.84
	0-100	PG2GLM100	35.84
	0-160	PG2GLM160	35.84
0-230	PG2GLM230	35.84	

50MM DIAL FACE LIQUID FILLED PRESSURE GAUGE
 STAINLESS STEEL CASE, BACK MOUNT, 1/4" BSP/T, DUAL SCALE PSI /KPA

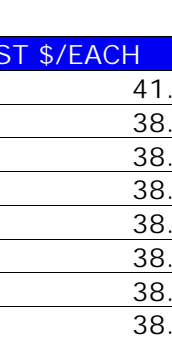
	PRESSURE RANGE PSI	PART No.	LIST \$/EACH
	0-30	PG2GBM30	40.95
	0-100	PG2GBM100	40.95
	0-160	PG2GBM160	40.95
0-230	PG2GBM230	40.95	

PRICES DO NOT INCLUDE GST
E&O.E

AIP PRESSURE GAUGES

50MM DIAL FACE DRY PRESSURE GAUGE

BLACK STEEL CASE, LOWER MOUNT, ¼" BSP/T, DUAL SCALE PSI /KPA

	PRESSURE RANGE PSI	PART No.	LIST \$/EACH
	0-100	PG2DLM100	30.02
	0-160	PG2DLM160	30.02
	0-200	PG2DLM200	30.02

50MM DIAL FACE DRY PRESSURE GAUGE

BLACK STEEL CASE, BACK MOUNT, ¼" BSP/T, DUAL SCALE PSI /KPA

	PRESSURE RANGE PSI	PART No.	LIST \$/EACH
	0-100	PG2DBM100	30.62
	0-160	PG2DBM160	30.62
	0-200	PG2DBM200	30.62

100MM DIAL FACE LIQUID FILLED PRESSURE GAUGE

STAINLESS STEEL CASE, LOWER MOUNT, 3/8" BSP/T, DUAL SCALE PSI /KPA

	PRESSURE RANGE PSI	PART No.	LIST \$/EACH
	0-60	PG4GLM60	132.30
	0-100	PG4GLM100	132.30
	0-160	PG4GLM160	132.30
	0-230	PG4GLM230	132.30
	0-400	PG4GLM400	132.30
	0-600	PG4GLM600	132.30
	0-1000	PG4GLM1000	132.30
	0-2000	PG4GLM2000	132.30

100MM DIAL FACE DRY PRESSURE GAUGE

BLACK STEEL CASE, LOWER MOUNT, 3/8" BSP/T, DUAL SCALE PSI /KPA

	PRESSURE RANGE PSI	PART No.	LIST \$/EACH
	0-60	PG4DLM60	66.15
	0-100	PG4DLM100	66.15
	0-160	PG4DLM160	66.15
	0-230	PG4DLM230	66.15

AIP VACUUM GAUGES

63MM FACE LIQUID FILLED VACUUM GAUGE

STAINLESS STEEL CASE, LOWER MOUNT, ¼" BSP/T, DUAL SCALE KPA - HG

	VACUUM RANGE	PART No.	LIST\$/EACH
	0-30 Hg	VG63	55.10

100MM FACE LIQUID FILLED VACUUM GAUGE

STAINLESS STEEL CASE, LOWER MOUNT, 3/8" BSP/T DUAL SCALE KPA – HG

	VACUUM RANGE	PART No.	LIST \$/EACH
	0-30 Hg	VG100	113.85

PRICES DO NOT INCLUDE GST
E&O.E

POWAFLEX®

QUALITY RUBBER, PVC & POLYURETHANE HOSE



Copyright Notice

© Advanced Industrial Products Pty Ltd 2012

This product catalogue and price list and its contents are subject to copyright under the laws of Australia and, through international treaties, other countries. The copyright is owned by Advanced Industrial Products Pty Ltd, or in the case of some of the materials, by third parties.

The material in this product catalogue and price list is for personal use only and may not be used for any other purpose without the prior written consent of Advanced Industrial Products Pty Ltd. You must not reproduce, transmit, adapt or otherwise exercise the copyright in the whole or any part of

this product catalogue and price list except with the prior written consent of Advanced Industrial Products Pty Ltd.

TERMS AND CONDITIONS OF SALE

1 EXCLUSION OF BUYER'S TERMS

- 1.1 It is expressly acknowledged and agreed that these terms operate to the exclusion of all and any terms and conditions issued by the Buyer whether before or after the date these conditions of sale come into effect.

2 ORDERS AND PERFORMANCE

- 2.1 The Company may make its acceptance of an order conditional upon a satisfactory credit assessment of the Buyer.
2.2 Unless otherwise agreed orders must be confirmed in writing and either mailed, couriered, or faxed.
2.3 The Company will use its best endeavours to fulfill accepted orders and comply with any requested or estimated date for delivery but time will not be of the essence in this regard and if the Company's ability to fulfill an accepted order is affected by circumstances or events beyond its control the Company may:
- (a) extend the date for delivery;
 - (b) with the Buyer's approval, alter the specifications for the goods to allow the substitution of equivalent goods; or
 - (c) cancel the order without liability for breach.

- 2.4 The Company's policy is one of constant improvement and therefore changes of specifications and performance data may be made by the Company without notice and without incurring liability to the Buyer.

3 PRICE

- 3.1 Prices charged for goods will be according to a Current Quotation for those goods. Otherwise they will be determined by the Company by reference to its standard prices in effect at the date of Delivery (whether notified to the Buyer or not and regardless of any prices contained in the order). The Company will use its best endeavours to notify the Buyer of price changes but bears no liability in this regard.
3.2 Unless specifically indicated, prices in quotation or elsewhere do not include insurance, special packing, delivery or tax.
3.3 Any reference to resale prices contained in the Company's standard price lists or other documents (if any) are recommended resale prices only and there is no obligation on the Buyer to comply with these recommendations.
3.4 Prices shown in the Company's price list are exclusive of GST unless otherwise stated and GST, where applicable, will be charged in accordance with current legislation.

- 3.5 The Buyer will be liable for all applicable taxes to the extent that they are not already included in the price.

4 DELIVERY AND PACKING

- 4.1 Unless otherwise agreed, goods sold to the Buyer shall be supplied ex the Company's premises, and FOB.
4.2 Unless otherwise agreed, prices include standard packing by the Company and any special packing will be to the Buyer's account.

5 PAYMENT

- 5.1 Terms of payment by the Buyer will be by net cash in exchange for goods; for Buyers fulfilling the Company's credit requirements - net cash within 30 days from the end of the month in which the invoice was issued; or otherwise as agreed in writing.
5.2 The Company will provide an invoice to the Buyer who will pay the invoice in full within the time specified.
5.3 All payments to the Company will be made without set-off, deduction or counterclaim.
5.4 If the Buyer fails to pay the invoice in full to the Company when due, the Company will be entitled (without prejudice to any other right or remedy it may have) to:
- (a) cancel or suspend any further delivery to the Buyer under any order; and
 - (b) charge the Buyer interest on the overdue amount at the rate of 15% p.a. from the date of invoice to the date of full and final payment (irrespective of whether the date of payment is before or after any judgment or award in respect of the overdue amount).
 - (c) Charge to the Buyer all third party costs incurred in demanding and recovery of payments due or recovery of goods.
 - (d) to enter the buyer's premises or the delivery site (or the premises of any associated Company or agent where the Goods are located) without liability for trespass or any resulting damage and retake possession of the goods.

6 CLAIMS

- 6.1 Any claim by the Buyer for incorrect orders, shortages, overcharges and the like will only be considered by the Company if made in writing and forwarded within 14 days of the date of the invoice to the Company's claims department.
6.2 Any claims by the Buyer for goods lost or damaged in transit following Delivery should be made to the relevant carrier or transport authority and unless otherwise agreed the Company is not responsible for such loss or damage.
6.3 Return of goods to the Company by the Buyer may only be made if the Company has agreed to that return and all such returns will be subject to a 15% handling charge with freight costs and risk remaining the responsibility of the Buyer, subject always to clause 8.

7 INSURANCE, RISK AND PROPERTY

- 7.1 Unless otherwise agreed, goods are not insured by the Company.
7.2 Title to all the goods delivered by the Company to the Buyer remains with the Company and does not pass to the Buyer until the Buyer pays all monies due for all goods supplied in cleared funds, regardless of whether certain goods have already been paid for by the Buyer.
7.3 If the Buyer pays a portion of an amount due to the Company for goods delivered to them, the Company retains all title to those goods until the Buyer makes full payment for the goods.
7.4 If the Buyer enters into an agreement for the bona fide sale to a third party for a portion of goods delivered by the Company to the Buyer, title only passes to the Buyer in respect of the goods that the third party is purchasing. Title to the remaining goods not purchased by the third party remains with the company until the Buyer has complied with clause 7.2.

8 WARRANTIES

- 8.1 All goods are warranted to the level provided by the manufacturer, the period commencing from the date of invoice by this Company to its customers. The return of goods shall be at the customer's expense and the Company reserves the right to repair or replace goods under warranty claim.
8.2 To the fullest extent permitted by law the Company will not be liable to the Buyer for loss of profit or other economic loss; direct, indirect or consequential loss; special, general or other damages; or other expenses or costs arising out of any breach of the Contract or any common law duty (including negligence) by the Company, its agents or employees.

9 OTHER ITEMS

- 9.1 The Company will be entitled to off set against any monies owing to the Buyer amounts owed to the Company by the Buyer under the Contract or on any other account.

10 MISCELLANEOUS

- 10.1 Each party acknowledges and agrees that:
- (a) the Contract represents the entire agreement between the parties and supersedes all previous agreements;
 - (b) it has not entered into the Contract in reliance on, or as a result of any statement or conduct of any kind (including without limitation, any representation, warranty, advice or undertaking);
 - (c) all conditions, warranties or other terms implied by statute or common law are excluded to the fullest extent permitted by law;
 - (d) the Contract may only be amended by agreement in writing.

11 DEFINITIONS AND INTERPRETATION

In these Conditions of Sale the following terms have the following meanings unless the context requires otherwise:

'Buyer' means a person from whom the Company accepts an order for goods.

'Contract' means the agreement constituted by the Company's acceptance of the Buyer's order and includes these Conditions of Sale.

'Delivery' means delivery of any goods to the Buyer or to a carrier arranged by the Buyer or the Company at the Buyer's request.

'Tax' means any tax, levy, charge or duty imposed by any governmental entity or authority (including, without limitation, GST and customs duty) on or in relation to goods sold to the Buyer (excluding taxes on the company's income and capital gains).

'Company' is that entity, the name of which appears on the face of the relevant invoice.

12 LEGAL JURISDICTION

These terms and conditions shall be governed by the laws of the State of Queensland notwithstanding the place in which the goods or any of them are to be delivered. The Customer submits to the exclusive Jurisdiction of the Courts of the State of Queensland.