



VALVES

INDEX

INDUSTRIAL HOSE & SHEET RUBBER

PVC & PU HOSE		RUBBER & PU HOSE	
	<u>PAGE</u>		<u>PAGE</u>
PVC Pressure Hose	1-6	Pumpowa Rubber Layflat Hose	24
Safety Yellow Hose	1	Irrigation Hose	26-27
TPR (Translucent Pressure Hose)	1	Travelflex Rubber Irrigation Hose	26
Tradeflex Hose	1	Powaflex P.U. Irrigation Hose	27
Tradeflex Fitted Assemblies	2	Wellman Polyurethane Bore Hose	28-29
Chemflex Hose	2	General Rubber & Polyurethane Hose	30-46
Hi-Spray Hose	2	Air & Water Delivery Hose	30
White Washdown Hose	3	Water Suction/Delivery Hose	30
Medium Drag Hose	3	Rockdrill/Bull Air Hose (Airminer)	30-31
Greenflex Ag-Ind	3	FRAS Air & Water Delivery Hose	31
FRAS Hose	4	FRAS Water Suction/Delivery Hose	31
Divers Air Hose	4	Steel Braid Air Hose	32
Drum Pump Hose	4	Yellow Pneumatic Air Hose	32
PR Hose	4	Contractors' Air Hose Assembly	32
Fire reel Hose & Fire Hose Assemblies	5	Hot Air Suction & Delivery Hose	32
Fire Kits – Assembled	5	Powaflex 1200 Hi-Temp Steel Air Hose	32
Fire Hose Reel	5	Multi-Purpose Hose	33
Sullage Hose – Reinforced & Unreinforced	6	G.P. Air & Water Hose	33
Washing Machine Hose	6	Rubber Firereel Hose	33
Drop Hose	6	Air Brake Hose	34
Garden Hose	7-8	Fuel Line Hose	34
Gardenflex	7	Push-On Hose (SAE100R6)	34
Allrounder II	7	Marine Exhaust Hose	34
Olympic Goldflex	7	Fuel & Oil Delivery Hose	35
Raynbo 5 & Raynbo 10	8	Fuel & Oil Suction & Delivery Hose	35
Soaker Hose	8	Paint Fluid Hose	36
Tubing	9-11	Farm Tank Drum Pump	36
Clear Vinyl Tubing	9	Radiator Hose (Straight Length)	36
Beverage Tube	9	Car Heater Hose	36
Self Store Hose	10	Silicone Radiator Hose	37
Nylon Tubing	10-11	Silicone Heater Hose	37
PVC Suction Hose	12-17	Welding Hose	38
Grey, Blue, Black	12	Washdown Hose	39
Blue, Black & Slurry (Super Elastic)	12	Standard Steam Hose	39
Red, Flexisteel	14	Steel Steam Hose	39
M.D. Translucent Green	15	Brewers' Delivery Hose	40
M.D. Non-Toxic Clear	15	Brewers' Suction/Delivery Hose	40
Agpond	15	Chemical Suction & Delivery Hose	40
Air Seeder Hose	16	Sandblast Hose	41
Magflex	16	Powavac P.U.	41
Sanitary Suction Hose	16	Contractors' Water Suction Hose	41
Spa Hose	17	Bulk Material Delivery Hose	42
Swimming Pool Hose	17	Muff Coupling Hose	42
G Vac Hose	17	Concrete Delivery Hose (40 & 85 bar)	42
Ducting	18-19	Powaflex P.U. Concrete Placement Hose	43
DTPR/RFH	18	Mineral Recovery Hose	44
Extractaflex	18	FRAS Cable Protection Hose	44
Ductor	19	FRAS Stone Dusting Hose	44
Polyurethane Ducting	19	Material Handling Hose (Swaged Ends)	45
PVC Layflat Hose	20-21	Contractors Suction Pump Hose Assemblies	46
Hi-Flo Blue, Red & Green Layflat Hose	20	Airflat Assemblies	46
Blueline, Redline & Agflat Layflat Hose	21	Rubber Expansion Joints	47
Potable Water (Drinking Water) Hose	22-23	Hydraulic Hose	48
Potable Water Braided Pressure Hose	22	1 & 2 Wire Non Skive (1SN & 2SN)	48
Potable Water Suction Hose	23	Spiral Guard	49
Potable Water Layflat Hose	23	S/Steel & Composite Hose	50
Polyurethane & Rubber Layflat Hose	24-25	Sheet Rubber Products	51-52
Polyurethane Mine Pit Dewatering Hose	24	Natural & Neoprene Insertion/Sheet Rubber	51
Airflat Long Length Layflat Air Hose	25	Rib, Studded & Ute Matting	52
Petroleum Long Length Layflat Hose	25	Flange Gaskets & Tarp Rings	52
Fire Fighting Hose	25		
		SEE OVER FOR PAGES 53-220	

FITTINGS, VALVES, NOZZLES, CLAMPS, REELS, GAUGES

	<u>PAGE</u>		<u>PAGE</u>
Camlock Couplings	53-60	Valves	140-169
Aluminium Camlocks	53-55	AIP, AGA, WaterMark & Adflo Ball Valves	140
Nyglass Camlocks	56	Flomax Lever & T-Handle Ball Valves	141
Polypropylene Camlocks	57	Floman, Adflo Lockable, LH/RH tank fitting	142
Brass Camlocks	58	Polytank Standard Ball & Gate Valve	142
Stainless Steel Camlocks	59	3-Way 'L' & 'T' Port Ball Valves	143
Camlock Accessories	60	Kitz 3-Way & Bronze Ball Valves	144
		Mini Ball Valves, Bibcocks, Fire Ball Nozzle	145
General Fittings	61-85	AGA Double Flared Gas Valve	145
Brass & Polypropylene Hose Couplings	61	Stainless Steel Ball Valves	146
Washers (To Suit Above)	61	3-Way 'L' & 'T' S/Steel Ball Valves	147
Bauer Type Couplings – Standard Duty	62	Stainless Steel Gate Valve	147
Bauer Type Couplings – Heavy Duty	63	S/Steel Swing & Spring Check	148
Bauer Type Couplings Parts & Accessories	64	Stainless Steel Y-Strainer	148
Bauer Type Aluminium Split Strainers	64	Stainless Steel Wafer Check Valve	148
Powafit HD Layflat Hose Couplings	65-66	PVC Compact & True Union Ball Valves	149
Powafit Claw Couplings – A Type	67	Polypropylene Ball Valves	150-151
Powafit Claw Couplings – S Type	68	Nylon Check Valve & Screen	152
Powafit Claw Clamps & Accessories	69	Air Vacuum Breaker	152
Powafit Quick Release Couplings	70-80	Barrel Union & Compression Couplings	153
Ground Joint Couplings	81	PVC Check Valves & Foot Valves	153
Combination Nipples	82	Brass Spring Check & Swing Check Valves	154
Steel & Malleable Iron Hose Joiners	82	Wafer Check Valve & Brass Y-Strainer	154
Brass Tank Fittings	82	Brass Gate Valves Ezi-Flo & AIP	155
Tank Outlet Rubber Gasket	82	AIP AS 1628 Tested Gate Valve	155
Muff Couplings	83	Bronze Untested Gate Valve	155
Flanged Hose Tails & Strainers	83	Knife Gate Valves	156
Stainless Steel Filters (Drawtubes)	83	Cast Iron Gate Valve	156
Storz Fittings	84-85	Butterfly Valves & Extensions	157
		Shouldered Butterfly Valves & Clamps	158
Quick Connect Couplings	86-90	Actuated Valves & Accessories	159-163
AIP Quick Connect Couplings	86	Filter Regulators & Lubricators	164-166
Ryco Couplings	87-88	Float Valves & Accessories	167
Jamec Couplings	89-90	Strainers & Foot Valves	168
Self Store Fittings	90	Brass Hose Cocks & Accessories	169
		Vacuum Breaker & Dual Check Valve	169
Brass Fittings	91-101	AIP Thread Tape & Duct Tape	170
Plumbing Screwed Brassware	102-104	Nozzles & Blow Guns	171-174
		Aluminium Nozzles	171
Legris Fittings & Tubing	105-111	Washdown Guns & Nozzles	171
Legris Brass Compression Fittings	105	Red Nylon Nozzles	172
Legris Push-In Fittings	106-108	Heavy Duty Nozzles	173
Legris Tubing	109-111	Blow Guns	174
Nylon Fittings	112-122	Clamps	175-192
Tefen Fittings (Blue)	112-115	Breeze 62 Series Worm Drive Clamps	175
Nylon Fittings (White)	116-122	Breeze 63 Series Worm Drive Clamps	176
		Breeze 73 Series Worm Drive Clamps	177
Nyglass & Poly Fittings & Risers	123-127	Double Ear Clamps	177
Nyglass & Polypropylene Screwed Fittings	123-126	Powaflex Worm Drive Clamps	178
Polypropylene Layflat Hose Fittings	126	Cobra Quick Fit Hose Clamps	179
Polypropylene Threaded Risers	127	Super Clamps Standard (Low Carbon)	180
		Super Clamps Stainless	181
Pipe Fittings	128-135	Super Clamp Merchandiser	182
Gal Mal Fittings	128-129	Worm Drive Clamp Merchandiser	183
Gal Steel Pipe Pieces	130	Band-It Clamps	184-187
Gal Steel Fittings	131	Double Bolt Clamps	188
Black Steel Fittings	132	4 & 6 Bolt & Spiral Clamps	189
Buttweld Fittings	133-134	Pipe Repair Clamps	190-192
Stainless Steel Screwed Fittings	135	Cable Ties	193
		Hose Reels	193-194
Raynbo Garden Fittings & Accessories	136-139	Retractable Hose Reels	193
Raynbo Plastic Snap-On Fittings	136	AIP Steel Hose Reels	194
Raynbo Brass Click-On Fittings	137	Hose Merchandisers	195-197
Raynbo Tap Timer, Sprinklers, Nozzles	138	Pressure Gauges	198-199
Raynbo Lilac Grey Water Snap-On Fittings	138		
Raynbo Spray Guns	139	Technical Information	200-220

BALL VALVES

AIP NICKEL PLATED BRASS BALL VALVE FULL PORT BSP/P THREAD F & F BLUE HANDLE PN40

	SIZE INCH	SIZE MM	PART No.	LIST \$/EACH
	1/4	6	AIPBV6	17.60
	3/8	10	AIPBV10	17.60
	1/2	12	AIPBV12	19.84
	3/4	20	AIPBV20	26.98
	1	25	AIPBV25	40.06
	1 1/4	32	AIPBV32	61.70
	1 1/2	38	AIPBV38	87.10
2	50	AIPBV50	137.00	

AGA GAS APPROVED NICKEL PLATED BRASS BALL VALVE FULL PORT BSP/T THREAD F & F YELLOW HANDLE

	SIZE INCH	SIZE MM	PART No.	LIST \$/EACH
	1/2	12	AGA12	21.08
	3/4	20	AGA20	28.50
	1	25	AGA25	42.00
	1 1/4	32	AGA32	64.40
	1 1/2	38	AGA38	89.50
2	50	AGA50	140.10	

DR WATERMARK BRASS BALL VALVE FULL PORT BSP/P THREAD F & F GREEN STAINLESS STEEL LEVER HANDLE & NUT PN25

	SIZE INCH	SIZE MM	PART No.	LIST \$/EACH
	1/2	15	DZBV15	18.65
	3/4	20	DZBV20	25.74
	1	25	DZBV25	38.06
	1 1/4	32	DZBV32	60.50
	1 1/2	38	DZBV38	78.76
2	50	DZBV50	112.98	

ADFLO F & F NICKEL PLATED BRASS BALL VALVE FULL PORT BSP/P THREAD STAINLESS STEEL BLUE HANDLE & NUT PN25

	SIZE INCH	SIZE MM	PART No.	LIST \$/EACH
	1/2	12	AFBV12	16.80
	3/4	20	AFBV20	23.00
	1	25	AFBV25	34.00
	1 1/4	32	AFBV32	54.00
	1 1/2	38	AFBV38	70.00
2	50	AFBV50	101.00	

ADFLO SSHN F & F NICKEL PLATED BRASS BALL VALVE FULL PORT BSP/T THREAD STAINLESS STEEL GREEN HANDLE & NUT PN25

	SIZE INCH	SIZE MM	PART No.	LIST \$/EACH
	1/2	12	AFBVSSHN12	16.80
	3/4	20	AFBVSSHN20	23.00
	1	25	AFBVSSHN25	34.00
	1 1/4	32	AFBVSSHN32	54.00
	1 1/2	38	AFBVSSHN38	70.00
2	50	AFBVSSHN50	101.00	

PRICES DO NOT INCLUDE GST
E&O.E

BALL VALVES

FLOMAX F & F NICKEL PLATED BRASS BALL VALVE FULL PORT BSP/P THREAD
STAINLESS STEEL BLACK HANDLE UP TO & INCLUDING 2", PN25
(SIZE 2½", 3" & 4" MILD STEEL HANDLE)

	SIZE INCH	SIZE MM	PART No.	LIST \$/EACH
	¼	6	FMBV6	14.50
	3/8	10	FMBV10	14.80
	½	12	FMBV12	15.20
	¾	20	FMBV20	21.05
	1	25	FMBV25	31.14
	1¼	32	FMBV32	49.50
	1½	38	FMBV38	64.40
	2	50	FMBV50	92.44
	2½	65	FMBV65	210.00
3	80	FMBV80	282.00	
4	100	FMBV100	460.00	

FLOMAX M & F NICKEL PLATED BRASS BALL VALVE FULL PORT BSP/T THREAD
STAINLESS STEEL RED HANDLE, PN25

	SIZE INCH	SIZE MM	PART No.	LIST \$/EACH
	¼	6	BV6MF	19.80
	3/8	10	BV10MF	24.80
	½	12	BV12MF	17.90
	¾	20	BV20MF	28.90
	1	25	BV25MF	39.40
	1¼	32	BV32MF	61.10
	1½	38	BV38MF	86.80
	2	50	BV50MF	119.60

FLOMAX T-HANDLE F & F NICKEL PLATED BRASS BALL VALVE FULL PORT BSP/P
THREAD, RED HANDLE, PN25

	SIZE INCH	SIZE MM	PART No.	LIST \$/EACH
	¼	6	T6FF	18.20
	3/8	10	T10FF	20.60
	½	12	T12FF	26.50
	¾	20	T20FF	37.60
	1	25	T25FF	53.00

FLOMAX T-HANDLE M & F NICKEL PLATED BRASS BALL VALVE FULL PORT
BSP/P THREAD, RED HANDLE, PN25

	SIZE INCH	SIZE MM	PART No.	LIST \$/EACH
	¼	6	T6MF	18.20
	3/8	10	T10MF	20.60
	½	12	T12MF	26.50
	¾	20	T20MF	37.60
	1	25	T25MF	53.00

PRICES DO NOT INCLUDE GST
E&O.E

BALL VALVES & POLYTANK STANDARD VALVES & FITTING

FLOMAN F & F NICKEL PLATED BRASS BALL VALVE, FULL PORT, BSP/P THREAD, STAINLESS STEEL BLUE HANDLE UP TO & INCLUDING 2". PN16.
(SIZE 2½", 3" & 4" MILD STEEL HANDLE)

	SIZE INCH	SIZE MM	PART No.	LIST \$/EACH
	½"	12	FMANBV12	13.68
	¾"	20	FMANBV20	18.95
	1"	25	FMANBV25	28.00
	1¼"	32	FMANBV32	44.55
	1½"	38	FMANBV38	57.95
	2"	50	FMANBV50	83.20
	2½"	65	FMANBV65	199.50
	3"	80	FMANBV80	267.90
4"	100	FMANBV100	437.00	

ADFLO F & F NICKEL PLATED BRASS BALL VALVE, FULL PORT, BSP/P THREAD, STAINLESS STEEL **LOCKABLE** BLUE HANDLE & NUT. PN25.

	SIZE INCH	SIZE MM	PART No.	LIST \$/EACH
	½	12	AFBVL12	18.48
	¾	20	AFBVL20	25.30
	1	25	AFBVL25	37.40
	1¼	32	AFBVL32	59.40
	1½	38	AFBVL38	77.00
	2	50	AFBVL50	111.10

POLYTANK STANDARD AS/NZS 2345 (APP. C)

FLOMAX DR BRASS BALL VALVE, FULL PORT, BSP/P THREAD, STAINLESS STEEL RED HANDLE, PN25.

	SIZE INCH	SIZE MM	PART No.	LIST \$/EACH
	½	12	PTSFMBV12	16.72
	¾	20	PTSFMBV20	23.15
	1	25	PTSFMBV25	34.25
	1¼	32	PTSFMBV32	54.45
	1½	38	PTSFMBV38	70.84
	2	50	PTSFMBV50	101.68

EZI-FLO DR BRASS GATE VALVE, BSP/P THREAD, PN16.

	SIZE INCH	SIZE MM	PART No.	LIST \$/EACH
	½	12	PTSEFBGV12	14.60
	¾	20	PTSEFBGV20	18.04
	1	25	PTSEFBGV25	23.20
	1¼	32	PTSEFBGV32	34.32
	1½	38	PTSEFBGV38	43.23
	2	50	PTSEFBGV50	63.35

DR BRASS TANK FITTING, LEFT HAND/RIGHT HAND THREAD, SILICON WASHER

	SIZE INCH		PART No.	LIST \$/EACH
	EXTERNAL BSP/P	INTERNAL BSP/P		
	¾	½	BTF20LR	11.55
	1	¾	BTF25LR	18.25
	1¼	1	BTF32LR	24.25
	1½	1¼	BTF38LR	26.40
	2	1½	BTF50LR	41.85

PRICES DO NOT INCLUDE GST
E&O.E

3-WAY NICKEL PLATED BRASS BALL VALVE BLACK HANDLE 'L' PORT

	SIZE INCH	SIZE MM	PART No.	LIST \$/EACH
	1/4	6	3WBVL6	58.12
	3/8	10	3WBVL10	58.12
	1/2	12	3WBVL12	61.42
	3/4	20	3WBVL20	84.22
	1	25	3WBVL25	119.25
	1 1/4	32	3WBVL32	180.75
	1 1/2	38	3WBVL38	243.75
2	50	3WBVL50	381.00	

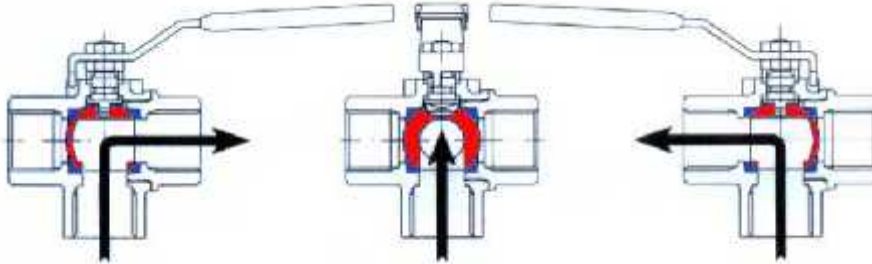

L-PORT

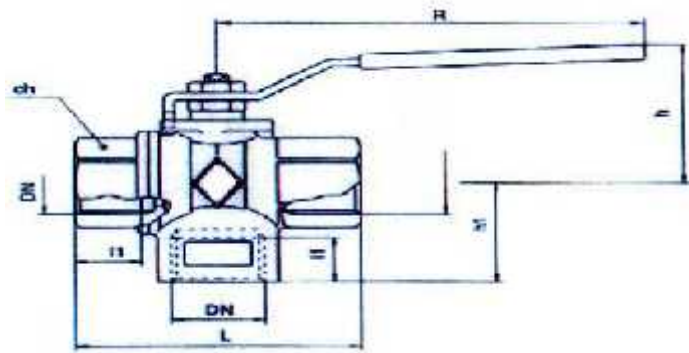

DN	ch	I1	L	h1	h	R	Kv	PN	Kg
1/4	8	22	11	52	26	42	2.25	25	0.22
3/8	10	22	11.4	52	26	42	2.7	25	0.19
1/2	15	27	15	64	33.5	45	6	25	0.30
3/4	20	32	16.3	74	39.5	57	11.5	16	0.49
1	25	41	19.1	89	47	60	18.3	16	0.81
1 1/4	32	50	21.4	100	54.5	66	27.2	10	1.30
1 1/2	40	55	21.4	110	61.25	81	47.3	10	1.76
2	50	70	25.7	130	72.75	103	73	10	2.63
3	80	105	33.3	197	106	152	177.5	6	9.50

3-WAY NICKEL PLATED BRASS BALL VALVE BLACK HANDLE 'T' PORT

	SIZE INCH	SIZE MM	PART No.	LIST \$/EACH
	1/4	6	3WBVT6	61.20
	3/8	10	3WBVT10	61.20
	1/2	12	3WBVT12	64.35
	3/4	20	3WBVT20	88.43
	1	25	3WBVT25	123.75
	1 1/4	32	3WBVT32	185.25
	1 1/2	38	3WBVT38	252.75
2	50	3WBVT50	387.75	

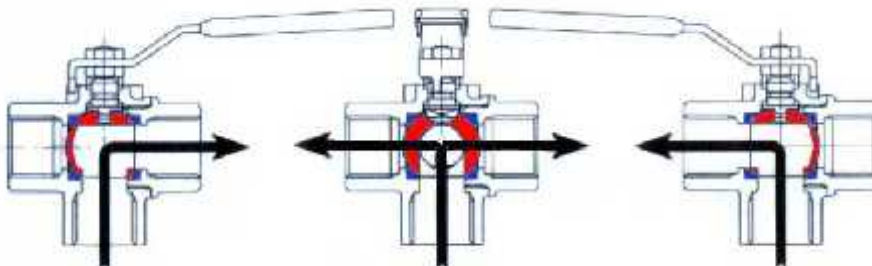

T-PORT

PRICES DO NOT INCLUDE GST
E&O.E

KITZ 3-WAY BRASS BALL VALVE ORANGE HANDLE 'L' PORT

	SIZE INCH	SIZE MM	PART No.	LIST \$/EACH
	1/4	6	KZ3WBV6	167.18
	3/8	10	KZ3WBV10	177.22
	1/2	12	KZ3WBV12	199.05
	3/4	20	KZ3WBV20	221.70
	1	25	KZ3WBV25	252.52
	1 1/4	32	KZ3WBV32	459.38
	1 1/2	38	KZ3WBV38	579.00
2	50	KZ3WBV50	897.00	

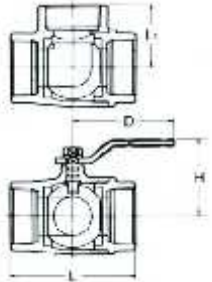
	DIMENSIONS MM								
	Valve Size mm	8	10	15	20	25	32	40	50
	Bore Size	4.5	6.8	10	15	20	25	32	40
	L Threaded end to end	40	46	67	68	78.5	89	100	115
	L1 Centre to end	20	23	33.5	34	39.5	44.5	50	57.5
	H Height	30	32	45	48	55	60	65	75
D Length of handle	60	80	100	100	130	130	130	150	

- 3-way body, screwed body cap, L-port ball
- PTFE seats, blowout-proof stem
- Threaded ends to BS21 (BSPT)
- 2760 kPa W.O.G. non-shock

PARTS	MATERIAL
Body	Brass
Body Cap	Brass
Stem	K-Metal
Ball	Brass (Chrome Plated)
Seat	PTFE
O-Ring	FPM (Viton)
Handle	Stainless Steel (Vinyl Grip) Ductile Iron

PRICES DO NOT INCLUDE GST
E&O.E

ADFLO MINI BALL VALVE F & F NICKEL PLATED BSP THREAD BLACK HANDLE

	SIZE INCH	SIZE MM	PART No.	LIST \$/EACH
	1/8	3	MBVF3	13.90
	1/4	6	MBVF6	13.90
	3/8	10	MBVF10	14.10
	1/2	12	MBVF12	16.20
	3/4	20	MBVF20	18.80

ADFLO MINI BALL VALVE M & F NICKEL PLATED BSP THREAD BLACK HANDLE

	SIZE INCH	SIZE MM	PART No.	LIST \$/EACH
	1/8	3	MBVM3	13.90
	1/4	6	MBVM6	13.90
	3/8	10	MBVM10	14.10
	1/2	12	MBVM12	16.20
	3/4	20	MBVM20	18.80

Working pressure 150 psi, brass body, teflon seat, aluminium handle.

BALL BI COCK

Red aluminium handle, BSP thread. Supplied with hose end.

	SIZE INCH	SIZE MM	PART No.	LIST \$/EACH
	1/2	12	BIB12	22.00
	3/4	20	BIB20	28.20
	1	25	BIB25	34.40

BALL BI COCK (LOCKABLE)

Supplied with lockable handle and hose end. BSP thread.

	SIZE INCH	SIZE MM	PART No.	LIST \$/EACH
	1/2	12	BIBLOCK12	52.66
	3/4	20	BIBLOCK20	53.46

BALL NOZZLE & HOSE TAIL

Brass hose tail to suit 20mm ID hose – 6mm outlet for fire and washdown applications.

	SIZE INCH	SIZE MM	PART No.	LIST \$/EACH
	3/4	20	BNHT20	40.00
	1	25	BNHT25	75.00

AGA DOUBLE FLARED GAS BALL VALVE

	SIZE INCH	SIZE MM	PART No.	LIST \$/EACH
	1/2	12	DFBV12	30.56
	3/4	20	DFBV20	40.90

PRICES DO NOT INCLUDE GST
E&O.E

FLOSTAR STAINLESS STEEL BALL VALVES

FLOSTAR V1

One piece reduced port with locking device, 316 stainless steel, 800 psi W.P., screwed ends.

	SIZE INCH	SIZE MM	PART No.	LIST \$/EACH
	1/4	6	V16	15.95
	3/8	10	V110	17.05
	1/2	12	V112	22.28
	3/4	20	V120	27.94
	1	25	V125	37.40
	1 1/4	32	V132	54.18
	1 1/2	38	V138	64.08
	2	50	V150	97.90
	2 1/2	65	V165	POA
3	80	V180	POA	

FLOSTAR V2

Two piece full port with locking device, 316 stainless steel, 1000 psi W.P., screwed ends.

	SIZE INCH	SIZE MM	PART No.	LIST \$/EACH
	1/4	6	V26	22.88
	3/8	10	V210	23.32
	1/2	12	V212	24.75
	3/4	20	V220	35.20
	1	25	V225	44.61
	1 1/4	32	V232	69.25
	1 1/2	38	V238	92.02
	2	50	V250	140.20
	2 1/2	65	V265	340.20
	3	80	V280	379.12
	4	100	V2100	1276.00

FLOSTAR V3

Three piece full port with locking device, 316 stainless steel, 1000 psi W.P., screwed ends (available with ISO mounting pad for actuating if required).

	SIZE INCH	SIZE MM	PART No.	LIST \$/EACH
	1/4	6	V36	31.19
	3/8	10	V310	32.34
	1/2	12	V312	39.88
	3/4	20	V320	58.36
	1	25	V325	68.15
	1 1/4	32	V332	106.87
	1 1/2	38	V338	153.07
	2	50	V350	222.37
	2 1/2	65	V365	493.80
	3	80	V380	607.00
4	100	V3100	1360.20	

PRICES DO NOT INCLUDE GST
E&O.E

STAINLESS STEEL VALVES

3-WAY STAINLESS STEEL 316 'L' PORT BALL VALVE, SCREWED ENDS, BSP/P
THREAD, 1000 PSI, PTFE SEAT

	SIZE INCH	SIZE MM	PART No.	LIST \$/EACH
	1/2	12	SS3WBVL12	154.40
	3/4	20	SS3WBVL20	173.70
	1	25	SS3WBVL25	212.30
	1 1/4	32	SS3WBVL32	299.15
	1 1/2	38	SS3WBVL38	318.45
	2	50	SS3WBVL50	424.60

3-WAY STAINLESS STEEL 316 'T' PORT BALL VALVE, SCREWED ENDS, BSP/P
THREAD, 1000 PSI, PTFE SEAT

	SIZE INCH	SIZE MM	PART No.	LIST \$/EACH
	1/2	12	SS3WBVT12	154.40
	3/4	20	SS3WBVT20	173.70
	1	25	SS3WBVT25	212.30
	1 1/4	32	SS3WBVT32	299.15
	1 1/2	38	SS3WBVT38	318.45
	2	50	SS3WBVT50	424.60

GATE VALVE - STAINLESS STEEL 316, BSP THREAD, 200 PSI W.P., PTFE SEAT

	SIZE INCH	SIZE MM	PART No.	LIST \$/EACH
	1/2	12	SSGV12	115.80
	3/4	20	SSGV20	125.45
	1	25	SSGV25	173.70
	1 1/4	32	SSGV32	231.60
	1 1/2	38	SSGV38	289.50
	2	50	SSGV50	308.80

PRICES DO NOT INCLUDE GST
E&O.E

STAINLESS STEEL VALVES

SWING CHECK VALVE – STAINLESS STEEL 316, BSP THREAD, PTFE SEAT

	SIZE INCH	SIZE MM	PART No.	LIST \$/EACH
	1/2	12	SSSWCH12	57.90
	3/4	20	SSSWCH20	71.41
	1	25	SSSWCH25	106.15
	1 1/4	32	SSSWCH32	164.05
	1 1/2	38	SSSWCH38	193.00
	2	50	SSSWCH50	231.60
	2 1/2	65	SSSWCH65	733.40
	3	80	SSSWCH80	868.50

SPRING CHECK VALVE – STAINLESS STEEL 316, BSP THREAD, 1000 PSI , PTFE SEAT

	SIZE INCH	SIZE MM	PART No.	LIST \$/EACH
	1/2	12	SSSPRV12	86.85
	3/4	20	SSSPRV20	96.50
	1	25	SSSPRV25	125.45
	1 1/4	32	SSSPRV32	154.40
	1 1/2	38	SSSPRV38	250.90
	2	50	SSSPRV50	328.10

Y STRAINER – STAINLESS STEEL 316, BSP THREAD, 600 PSI , PTFE SEAT

	SIZE INCH	SIZE MM	PART No.	LIST \$/EACH
	1/2	12	SSYS12	48.25
	3/4	20	SSYS20	96.50
	1	25	SSYS25	96.50
	1 1/4	32	SSYS32	135.10
	1 1/2	38	SSYS38	173.70
	2	50	SSYS50	202.65
	2 1/2	65	SSYS65	617.60
	3	80	SSYS80	868.50

WAFER DUO CHECK VALVE – STAINLESS STEEL 316 (FLANGED ANSI 150) 150lb

	SIZE INCH	SIZE MM	PART No.	LIST \$/EACH
	2	50	SSWCV50	579.00
	2 1/2	65	SSWCV65	598.30
	3	80	SSWCV80	926.40
	4	100	SSWCV100	1196.60
	6	150	SSWCV150	1737.00
	8	200	SSWCV200	3088.60

Other stainless steel valves available POA.

PRICES DO NOT INCLUDE GST
E&O.E

PVC BALL VALVES

PVC COMPACT BALL VALVE, F & F BSP THREAD, PN10

	SIZE INCH	SIZE MM	PART No.	LIST \$/EACH
	1/2	12	PVCBVT12	4.60
	3/4	20	PVCBVT20	6.35
	1	25	PVCBVT25	9.05
	1 1/4	32	PVCBVT32	12.20
	1 1/2	38	PVCBVT38	18.90
	2	50	PVCBVT50	24.45
	2 1/2	65	PVCBVT65	96.00
	3	75	PVCBVT75	102.20
4	100	PVCBVT100	152.00	

PVC COMPACT BALL VALVE, SOLVENT WELD

	SIZE INCH	SIZE MM	PART No.	LIST \$/EACH
	1/2	12	PVCBVS12	4.60
	3/4	20	PVCBVS20	6.35
	1	25	PVCBVS25	9.05
	1 1/4	32	PVCBVS32	12.20
	1 1/2	38	PVCBVS38	18.90
	2	50	PVCBVS50	24.45
	2 1/2	65	PVCBVS65	96.00
	3	75	PVCBVS75	102.20
4	100	PVCBVS100	152.00	

TRUE UNION PVC BALL VALVE, PTFE SEAT, BSP THREAD, PN10

	SIZE INCH	SIZE MM	PART No.	LIST \$/EACH
	1/2	12	TUBVT12	32.18
	3/4	20	TUBVT20	40.32
	1	25	TUBVT25	53.63
	1 1/4	32	TUBVT32	71.50
	1 1/2	38	TUBVT38	94.88
	2	50	TUBVT50	130.85
	2 1/2	65	TUBVT65	214.50
	3	75	TUBVT75	350.46
4	100	TUBVT100	716.43	

TRUE UNION PVC BALL VALVE, PTFE SEAT, SOLVENT WELD

	SIZE INCH	SIZE MM	PART No.	LIST \$/EACH
	1/2	12	TUBVSW12	32.18
	3/4	20	TUBVSW20	40.32
	1	25	TUBVSW25	53.63
	1 1/4	32	TUBVSW32	71.50
	1 1/2	38	TUBVSW38	94.88
	2	50	TUBVSW50	130.85
	2 1/2	65	TUBVSW65	214.50
	3	75	TUBVSW75	350.46
4	100	TUBVSW100	716.43	

PRICES DO NOT INCLUDE GST
E&O.E

POLYPROPYLENE BALL VALVES

AKWA POLYPROPYLENE BALL VALVE, F & F, BSP/T THREAD. PN16.

SIZE INCH	SIZE MM	PART No.	LIST \$/EACH
1/2	12	AKWA12	19.70
3/4	20	AKWA20	20.85
1	25	AKWA25	26.95
1 1/4	32	AKWA32	38.80
1 1/2	38	AKWA38	46.90
2	50	AKWA50	59.85

POLYPROPYLENE LEVER HANDLE BALL VALVE, FULL BORE, BSP/P FEMALE THREAD. PN16.

Brass ball and stem, red nylon lever handle, NBR o-ring and PTFE seats.

SIZE INCH	SIZE MM	W.P. PSI	PART No.	LIST \$/EACH
1/4	6	232	PPBVLH6	10.23
3/8	10	232	PPBVLH10	10.23
1/2	12	232	PPBVLH12	10.40
3/4	20	232	PPBVLH20	13.77
1	25	232	PPBVLH25	18.28
1 1/4	32	232	PPBVLH32	30.47
1 1/2	38	232	PPBVLH38	45.65
2	50	232	PPBVLH50	65.31

POLYPROPYLENE BUTTERFLY HANDLE BALL VALVE, FULL BORE, BSP/P FEMALE THREAD. PN16.

Brass ball and stem, red nylon butterfly handle, NBR o-ring and PTFE seats.

SIZE INCH	SIZE MM	W.P. PSI	PART No.	LIST \$/EACH
1/4	6	232	PPVBH6	10.23
3/8	10	232	PPVBH10	10.23
1/2	12	232	PPVBH12	10.40
3/4	20	232	PPVBH20	13.77
1	25	232	PPVBH25	18.28
1 1/4	32	232	PPVBH32	30.47

POLYPROPYLENE BALL BIBCOCK, LEVER HANDLE, BSP/P FEMALE THREAD. PN16.

Brass inlet thread, ball and stem; red nylon lever handle; NBR o-ring and PTFE seats.

SIZE INCH	SIZE MM	W.P. PSI	PART No.	LIST \$/EACH
1/2	12	232	PPBC12	12.21
3/4	20	232	PPBC20	19.27
1	25	232	PPBC25	30.27

PRICES DO NOT INCLUDE GST
E&O.E

POLY BALL VALVES

POLY BALL VALVE: 2 WAY BALL VALVE – LOW PRESSURE

Glass reinforced polypropylene, Teflon ball seal, EPDM gasket, 90 degree on/off with 8mm mounting threads (some models only).

	SIZE INCH	SIZE MM	W.P. PSI	PART No.	LIST \$/EACH
	1/2	12	240	BV12POLY	58.06
	3/4	20	240	BV20POLY	58.06
	1	25	240	BV25POLY	69.35
	1 1/4	32	150	BV32POLY	111.65
	1 1/2	38	150	BV38POLY	149.40
2	50	150	BV50POLY	206.85	

SIZE FEM BSP	PRESSURE PSI	LENGTH	WIDTH (MM)	HEIGHT
1/2"	240	86	58	57
1"	240	100	67	66
1 1/4"	150	111	80	71
1 1/2"	150	130	95	80
2"	150	150	110	108

POLY BALL VALVE: 3 WAY BALL VALVE – LOW PRESSURE

Three way as above with 180 degree three way on/off.

	SIZE INCH	SIZE MM	W.P. PSI	PART No.	LIST \$/EACH
	1/2	12	240	3BV12POLY	70.13
	3/4	20	240	3BV20POLY	75.13
	1	25	240	3BV25POLY	83.75
	1 1/4	32	150	3BV32POLY	133.13
	1 1/2	38	150	3BV38POLY	178.75
2	50	150	3BV50POLY	232.75	

SIZE FEM BSP	PRESSURE PSI	LENGTH	WIDTH (MM)	HEIGHT
1/2"	240	86	58	75
3/4"	240	86	58	85
1"	240	100	67	90
1 1/4"	150	111	80	95
1 1/2"	150	130	95	105
2"	150	150	110	140

PRICES DO NOT INCLUDE GST
E&O.E

NYLON CHECK VALVES

Spring loaded

Non-corrosive

High flow

Robust design

SIZE INCH	SIZE MM	W.P. PSI	PART No.	LIST \$/EACH
3/4	20	200	ACV20	29.66
1	25	200	ACV25	31.61
1 1/4	32	200	ACV32	34.97
1 1/2	40	200	ACV40	47.25
2	50	200	ACV50	69.72

MATERIAL

Body: glass fibre reinforced nylon

Spring: stainless steel

Plunger: nylon

Washer: nitrile rubber

O ring: nitrile rubber

Max W.P.: 235 psi @ 20°C

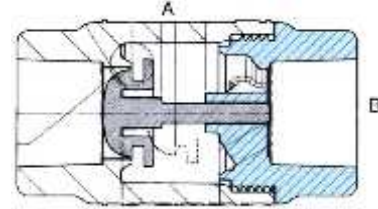

VALVE SIZES

	20mm	25mm	32mm	40mm	50mm
A	85mm	90mm	110mm	122mm	139mm
B	46mm	54mm	64mm	74mm	90mm

POLYPROPYLENE FILTER SCREEN

BSP/T thread.

SIZE INCH	SIZE MM	PART No.	LIST \$/EACH
3/4	20	AFS20	2.76
1	25	AFS25	2.98
1 1/4	32	AFS32	3.29
1 1/2	38	AFS38	4.50
2	50	AFS50	4.85

AIR VACUUM BREAKER

Female BSP thread – nylon glass fibre reinforced. stainless steel spring, acetyl plunger, nitrile seals.

SIZE INCH	SIZE MM	PART No.	LIST \$/EACH
1	25	ARV25	32.95

PRICES DO NOT INCLUDE GST
E&O.E

BARREL UNION PVC - THREADED

	PART No.	SIZE MM	LIST \$/EACH
	AIPYPVBUT15	15	2.55
	AIPYPVBUT20	20	3.15
	AIPYPVBUT25	25	4.59
	AIPYPVBUT32	32	6.00
	AIPYPVBUT40	40	8.10
	AIPYPVBUT50	50	12.90

PVC COMPRESSION COUPLINGS

	PART No.	SIZE MM	LIST \$/EACH
	AIPYPVRC20	20	2.85
	AIPYPVRC25	25	3.90
	AIPYPVRC32	32	5.55
	AIPYPVRC40	40	6.60
	AIPYPVRC50	50	8.85
	AIPYPVRC80	80	28.05
	AIPYPVRC100	100	40.50

PVC CHECK VALVES

	PART No.	SIZE INCH	DESCRIPTION	LIST \$/EACH
	AIPYPVCV015	1/2"	PVC Check Valve – Single Union	6.30
	AIPYPVCV020	3/4"	PVC Check Valve – Single Union	7.20
	AIPYPVCV025	1"	PVC Check Valve – Single Union	9.60
	AIPYPVCV032	1 1/4"	PVC Check Valve – Single Union	13.50
	AIPYPVCV040	1 1/2"	PVC Check Valve – Single Union	14.85
	AIPYPVCV050	2"	PVC Check Valve – Single Union	18.60
	AIPYPVCV065	2 1/2"	PVC Check Valve – Swing	52.50
	AIPYPVCV080	3"	PVC Check Valve – Swing	64.50
	AIPYPVCV100	4"	PVC Check Valve – Swing	99.00

PVC FOOT VALVES

	PART No.	SIZE INCH	LIST \$/EACH
	AIPYPVFO15	1/2"	5.40
	AIPYPVFO20	3/4"	6.75
	AIPYPVFO25	1"	8.10
	AIPYPVFO32	1 1/4"	13.35
	AIPYPVFO40	1 1/2"	15.90
	AIPYPVFO50	2"	18.90
	AIPYPVFO65	2 1/2"	63.00
	AIPYPVFO80	3"	102.00
	AIPYPVFO100	4"	156.00
	AIPYPVFO150	6"	405.00

PRICES DO NOT INCLUDE GST
E&O.E

BRASS SPRING CHECK VALVE F & F BSP

	SIZE INCH	SIZE MM	PART No.	LIST \$/EACH
	1/4	6	SPRV6	28.70
3/8	10	SPRV10	28.70	
1/2	12	SPRV12	13.72	
3/4	20	SPRV20	18.22	
1	25	SPRV25	24.70	
1 1/4	32	SPRV32	35.50	
1 1/2	38	SPRV38	46.80	
2	50	SPRV50	63.80	
2 1/2	63	SPRV63	143.20	
3	76	SPRV76	189.00	
4	100	SPRV100	330.60	

HEAVY DUTY BRASS SPRING CHECK VALVE

Brass disc and body, stainless steel spring, NBR gasket. Temperature range -5°C to +100°C – 150 psi.

	SIZE INCH	SIZE MM	PART No.	LIST \$/EACH
	1/2	12	SPRVHD12	21.26
3/4	20	SPRVHD20	27.64	
1	25	SPRVHD25	37.20	
1 1/4	32	SPRVHD32	57.14	
1 1/2	38	SPRVHD38	76.46	
2	50	SPRVHD50	105.00	

BRASS SWING CHECK VALVE F & F BSP/P

	SIZE INCH	SIZE MM	PART No.	LIST \$/EACH
	1/2	12	SWCH12	14.60
3/4	20	SWCH20	19.70	
1	25	SWCH25	28.30	
1 1/4	32	SWCH32	39.50	
1 1/2	38	SWCH38	55.60	
2	50	SWCH50	85.80	
2 1/2	63	SWCH63	185.30	
3	76	SWCH76	202.80	
4	100	SWCH100	332.40	

WAFER CHECK VALVE

Dual plate BS10 Table 'E'.
 Body: cast iron A126 Class B
 Plate: 316 stainless steel
 Seat: Buna-N rubber
 Spring: 316 stainless steel

	SIZE INCH	SIZE MM	PART No.	LIST \$/EACH
	2	50	WCV50	136.85
2 1/2	65	WCV65	147.55	
3	80	WCV80	169.51	
4	100	WCV100	227.70	
5	125	WCV125	302.34	
6	150	WCV150	390.54	
8	200	WCV200	645.15	
10	250	WCV250	968.30	
12	300	WCV300	1464.53	
14	350	WCV350	2403.50	
16	400	WCV400	3353.58	
18	450	WCV450	5291.50	
20	500	WCV500	6659.60	
24	600	WCV600	9843.40	

Y STRAINER BRASS

	SIZE INCH	SIZE MM	PART No.	LIST \$/EACH
	3/8	10	BYS10	25.00
1/2	12	BYS12	13.70	
3/4	20	BYS20	19.50	
1	25	BYS25	30.00	
1 1/4	32	BYS32	47.50	
1 1/2	38	BYS38	65.00	
2	50	BYS50	95.00	
2 1/2	65	BYS65	POA	
3	80	BYS80	POA	
4	100	BYS100	POA	

PRICES DO NOT INCLUDE GST
E&O.E

BRASS, BRONZE & TESTED AS 1628 GATE VALVES

EZI-FLO BRASS GATE VALVE, F & F BSP/P THREAD, PN16

	SIZE INCH	SIZE MM	PART No.	LIST \$/EACH
	1/2	12	EFBGV12	13.28
	3/4	20	EFBGV20	16.40
	1	25	EFBGV25	21.10
	1 1/4	32	EFBGV32	31.20
	1 1/2	38	EFBGV38	39.30
	2	50	EFBGV50	57.60
	2 1/2	63	EFBGV63	128.76
	3	76	EFBGV76	174.60
	4	100	EFBGV100	281.70

AIP BRASS GATE VALVE, F & F BSP/T THREAD, FULL PORT, PN16

	SIZE INCH	SIZE MM	PART No.	LIST \$/EACH
	1/2	12	BGV12	16.44
	3/4	20	BGV20	20.80
	1	25	BGV25	26.00
	1 1/4	32	BGV32	39.60
	1 1/2	38	BGV38	51.60
	2	50	BGV50	78.38
	2 1/2	63	BGV63	159.20
	3	76	BGV76	208.60
	4	100	BGV100	339.00

BRONZE UNTESTED GATE VALVE, F & F BSP/P, FULL PORT, PN16

	SIZE INCH	SIZE MM	PART No.	LIST \$/EACH
	1/2	12	UTGV12	28.14
	3/4	20	UTGV20	37.20
	1	25	UTGV25	49.50
	1 1/4	32	UTGV32	69.50
	1 1/2	38	UTGV38	93.90
	2	50	UTGV50	127.50
	2 1/2	63	UTGV63	258.80
	3	76	UTGV76	364.80
	4	100	UTGV100	589.00

AIP TESTED DR BRASS GATE VALVE, AS 1628, BSP/P, FULL PORT, PN20

	SIZE INCH	SIZE MM	PART No.	LIST \$/EACH
	1/2	12	TGVI12	38.40
	3/4	20	TGVI20	46.58
	1	25	TGVI25	60.48
	1 1/4	32	TGVI32	82.80
	1 1/2	38	TGVI38	114.00
	2	50	TGVI50	150.87
	2 1/2	63	TGVI63	487.80
	3	76	TGVI76	675.00
	4	100	TGVI100	973.50

PRICES DO NOT INCLUDE GST
E&O.E

KNIFE & CAST IRON GATE VALVES

KNIFE GATE VALVE

Epoxy coated, bi-directional flow, 7 bar pressure rating, rising stem, Grade 316 stainless steel blade and stem, flanged to Table E. Applications include mining, slurry, pulp, water.

SIZE INCH	SIZE MM	PART No.	LIST \$/EACH
2	50	KGV50	519.10
2½	65	KGV65	763.20
3	80	KGV80	882.60
4	100	KGV100	1170.42
5	125	KGV125	1610.21
6	150	KGV150	1874.40
8	200	KGV200	2774.48
10	250	KGV250	4157.05
12	300	KGV300	5371.56
14	350	KGV350	7488.00
16	400	KGV400	8733.50
18	450	KGV450	9873.60
20	500	KGV500	POA
24	600	KGV600	POA

KNIFE GATE VALVE – STAINLESS STEEL

Full stainless steel construction, lugged design.

Seat design: metal/metal (integral)

Flange drilling: Table E

Body material: stainless steel 316

Gate material: stainless steel 316

Seat material: integral, stainless steel 316

Superstructure: stainless steel 304

Packing: PTFE imp. syntex fibre

W.P.: 10 bar

SIZE INCH	SIZE MM	PART No.	LIST \$/EACH
2	50	KGV50	945.00
3	80	KGV80	1097.00
4	100	KGV100	1531.50
6	150	KGV150	2260.00
8	200	KGV200	3098.00
10	250	KGV250	4742.00
12	300	KGV300	5775.70
14	350	KGV350	POA
16	400	KGV400	POA
18	450	KGV450	POA
20	500	KGV500	POA
24	600	KGV600	POA

CAST IRON GATE VALVE – NON-RISING STEM

Blue epoxy coated, class: PN16

BS5163, drilling: Table E

SIZE INCH	SIZE MM	PART No.	LIST \$/EACH
2	50	CIGV50	264.50
2½	65	CIGV65	313.90
3	80	CIGV80	364.78
4	100	CIGV100	494.52
5	125	CIGV125	732.70
6	150	CIGV150	895.30
8	200	CIGV200	1397.50
10	250	CIGV250	2299.45
12	300	CIGV300	3171.98
14	350	CIGV350	POA
16	400	CIGV400	POA
18	450	CIGV450	POA
20	500	CIGV500	POA

PRICES DO NOT INCLUDE GST
E&O.E

AIP BUTTERFLY VALVES

WAFER BODY - LEVER HANDLE 316 stainless steel disc, 410 stainless steel stem, NBR seat, Table E

	SIZE INCH	SIZE MM	PART No.	LIST \$/EACH
	2	50	BFVWLW50	119.20
	2½	65	BFVWLW65	132.15
	3	80	BFVWLW80	150.80
	4	100	BFVWLW100	185.20
	5	125	BFVWLW125	250.50
	6	150	BFVWLW150	263.00
	8	200	BFVWLW200	478.00
	10	250	BFVWLW250	754.80
	12	300	BFVWLW300	1010.90

WAFER BODY - GEAR OPERATED 316 stainless steel disc, 410 stainless steel stem, NBR seat, Table E

	SIZE INCH	SIZE MM	PART No.	LIST \$/EACH
	2	50	BFGOW50	164.20
	3	80	BFGOW80	190.60
	4	100	BFGOW100	220.85
	5	125	BFGOW125	263.72
	6	150	BFGOW150	298.60
	8	200	BFGOW200	642.25
	10	250	BFGOW250	844.75
	12	300	BFGOW300	1123.75
	14	350	BFGOW350	1540.00
	16	400	BFGOW400	2519.00
	18	450	BFGOW450	3777.00
	20	500	BFGOW500	4840.00
	24	600	BFGOW600	5877.00

Larger sizes available on request.

FULL LUG BODY – LEVER HANDLE

	SIZE INCH	SIZE MM	PART No.	LIST \$/EACH
	2	50	BFVWLL50	154.96
	2½	65	BFVWLL65	169.15
	3	80	BFVWLL80	199.80
	4	100	BFVWLL100	240.75
	5	125	BFVWLL125	308.15
	6	150	BFVWLL150	381.25
	8	200	BFVWLL200	597.50
	10	250	BFVWLL250	1034.10
	12	300	BFVWLL300	1314.15

Discs also available in aluminium, bronze and ductile iron POA.

BUTTERFLY VALVE EXTENSIONS - GALVANIZED COLUMN, MILD STEEL SHAFT

Extensions are available in standard module lengths of either 1 metre or 1.5 metres, to suit wafer body valves (lever or gear operated) as per the table below. These modules can be bolted together if necessary, in any combination, to achieve extension heights required. For non-standard extension heights and for lugged body valve extensions, please contact your nearest AIP sales office.

	VALVE SIZE INCH	VALVE SIZE MM	MODULE EXTENSION LENGTHS	PART No.	LIST \$/EACH
	4	100	1 metre	BFVWEXT41000	306.00
	4	100	1.5 metres	BFVWEXT41500	318.00
	6	150	1 metre	BFVWEXT61000	322.00
	6	150	1.5 metres	BFVWEXT61500	334.00
	8	200	1 metre	BFVWEXT81000	336.00
	8	200	1.5 metres	BFVWEXT81500	342.00
	10	250	1 metre	BFVWEXT101000	388.00
	10	250	1.5 metres	BFVWEXT101500	404.00
	12	300	1 metre	BFVWEXT121000	388.00
	12	300	1.5 metres	BFVWEXT121500	404.00

Other sizes available POA.

PRICES DO NOT INCLUDE GST
E&O.E

SHOULDERED BUTTERFLY VALVES & CLAMPS

SHOULDERED BUTTERFLY VALVES

Shouldered ends, ductile iron body, NBR (nitrile) encapsulated ductile iron disc, stainless steel stem. PN20 rated.

LEVER OPERATED

	SIZE INCH	SIZE MM	PART No.	LIST \$/EACH
	3	80	BFVLS80	POA
	*4	100	BFVLS100	336.00
	*6	150	BFVLS150	615.84
	8	200	BFVLS200	POA
	10	250	BFVLS250	POA
	12	300	BFVLS300	POA

GEAR OPERATED - LOCKABLE

	SIZE INCH	SIZE MM	PART No.	LIST \$/EACH
	3	80	BFVGS80	POA
	*4	100	BFVGS100	536.64
	*6	150	BFVGS150	816.96
	8	200	BFVGS200	POA
	10	250	BFVGS250	POA
	12	300	BFVGS300	POA

SHOULDERED CLAMPS

Material: SG iron, complete with Buna-N nitrile gasket.

BOLTED TYPE

	SIZE INCH	NOMINAL BORE MM	O.D. MM	PART No.	LIST \$/EACH
	2	50	60.3	SHDCLPBT50	25.80
	3	80	88.9	SHDCLPBT80	33.96
	*4	100	114.3	SHDCLPBT100	38.60
	*6	150	165.1	SHDCLPBT150	72.41
	8	200	219.1	SHDCLPBT200	129.68

QUICK RELEASE TYPE

	SIZE INCH	NOMINAL BORE MM	O.D. MM	PART No.	LIST \$/EACH
	2	50	60.3	SHDCLPQR50	75.10
	3	80	88.9	SHDCLPQR80	89.77
	*4	100	114.3	SHDCLPQR100	56.42
	*6	150	165.1	SHDCLPQR150	73.00
	8	200	219.1	SHDCLPQR200	199.83

*Standard stock sizes

PRICES DO NOT INCLUDE GST
E&O.E

BRASS BALL VALVES PLUS ACTUATORS



SIZE N.B.	BSP THREAD	VALVE COMPLETE WITH DOUBLE ACTING AIR ACTUATOR	LIST \$/EACH	VALVE COMPLETE WITH SINGLE ACTING/SPRING RETURN AIR ACTUATOR	LIST \$/EACH	VALVE COMPLETE WITH ELECTRIC ACTUATOR	LIST \$/EACH
15	½	BBVDA15	POA	BBVSASR15	POA	BBVEA15	POA
20	¾	BBVDA20	POA	BBVSASR20	POA	BBVEA20	POA
25	1	BBVDA25	POA	BBVSASR25	POA	BBVEA25	POA
32	1¼	BBVDA32	POA	BBVSASR32	POA	BBVEA32	POA
40	1½	BBVDA40	POA	BBVSASR40	POA	BBVEA40	POA
50	2	BBVDA50	POA	BBVSASR50	POA	BBVEA50	POA
65	2½	BBVDA65	POA	BBVSASR65	POA	BBVEA65	POA
80	3	BBVDA80	POA	BBVSASR80	POA	BBVEA80	POA
100	4	BBVDA100	POA	BBVSASR100	POA	BBVEA100	POA

VALVE DETAILS

159



- Hot forged, nickel plated brass body and cap sealed with Loctite
- Finest brass according to DIN 17860 and UNI 5705-65 specifications
- Valve length according to DIN 3357 specification
- ISO 5211 and DIN 3337 mounting flange to actuator
- 100% full port for maximum flow
- Zero leakage guaranteed by seal test on each drive
- PTFE seats with flexible-lip and wear compensation design
- No metal-to-metal moving parts
- Especially designed blowout-proof brass stem
- 40 bar (Kg/cm²) non-shock cold working pressure
- -20 C + 170 C temperature

									
<u>AIR ACTUATORS</u> OPERATING PRESSURE – 6 BAR FOR SOLENOID OPERATED OPEN/CLOSE CONTROL, REFER TO SOLENOID VALVE – SVN32/52*	<u>ELECTRIC ACTUATORS</u> AVAILABLE IN VOLTAGES <table style="margin-left: auto; margin-right: auto;"> <tr> <td>D.C.</td> <td>A.C.</td> </tr> <tr> <td>12</td> <td>24</td> </tr> <tr> <td>24</td> <td>110</td> </tr> <tr> <td>110</td> <td>220/240</td> </tr> </table>	D.C.	A.C.	12	24	24	110	110	220/240
D.C.	A.C.								
12	24								
24	110								
110	220/240								

PRICES DO NOT INCLUDE GST
E&O.E



STAINLESS STEEL BALL VALVES PLUS ACTUATORS

SIZE N.B.	BSP THREAD	VALVE COMPLETE WITH DOUBLE ACTING AIR ACTUATOR	LIST \$/EACH	VALVE COMPLETE WITH SINGLE ACTING/SPRING RETURN AIR ACTUATOR	LIST \$/EACH	VALVE COMPLETE WITH ELECTRIC ACTUATOR	LIST \$/EACH
15	1/2	SSBVDA15	POA	SSBVSASR15	POA	SSBVEA15	POA
20	3/4	SSBVDA20	POA	SSBVSASR20	POA	SSBVEA20	POA
25	1	SSBVDA25	POA	SSBVSASR25	POA	SSBVEA25	POA
32	1 1/4	SSBVDA32	POA	SSBVSASR32	POA	SSBVEA32	POA
40	1 1/2	SSBVDA40	POA	SSBVSASR40	POA	SSBVEA40	POA
50	2	SSBVDA50	POA	SSBVSASR50	POA	SSBVEA50	POA
65	2 1/2	SSBVDA65	POA	SSBVSASR65	POA	SSBVEA65	POA
80	3	SSBVDA80	POA	SSBVSASR80	POA	SSBVEA80	POA
100	4	SSBVDA100	POA	SSBVSASR100	POA	SSBVEA100	POA

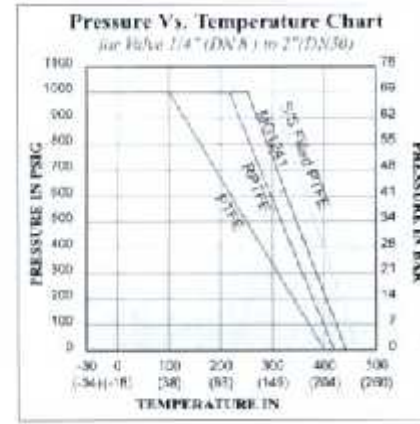
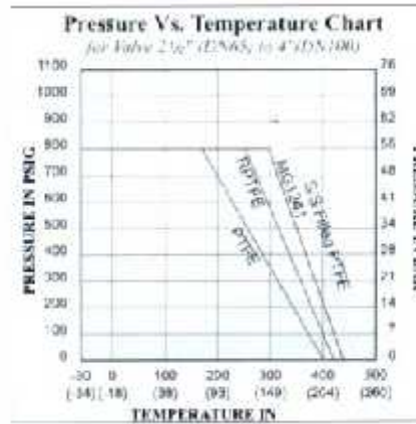
VALVE DETAILS



160

									
<p>AIR ACTUATORS OPERATING PRESSURE – 6 BAR FOR SOLENOID OPERATED OPEN/CLOSE CONTROL, REFER TO SOLENOID VALVE SVN32/52*</p>	<p>ELECTRIC ACTUATORS AVAILABLE IN VOLTAGES</p> <table border="0"> <tr> <td>D.C.</td> <td>A.C.</td> </tr> <tr> <td>12</td> <td>24</td> </tr> <tr> <td>24</td> <td>110</td> </tr> <tr> <td>110</td> <td>220/240</td> </tr> </table>	D.C.	A.C.	12	24	24	110	110	220/240
D.C.	A.C.								
12	24								
24	110								
110	220/240								

PRICES DO NOT INCLUDE GST
E&O.E

BUTTERFLY VALVE PLUS ACTUATORS

SIZE N.B.	TABLE E	E.P.D.M. SEAT	WAFER C.I. BODY	316 S/S DISC	316 S/S STEM	VALVE COMPLETE WITH DOUBLE ACTING AIR ACTUATOR	LIST \$/EACH	VALVE COMPLETE WITH SINGLE ACTING/SPRING RETURN ACTUATOR	LIST \$/EACH
50	✓	✓	✓	✓	✓	BFVDA50	380.00	BFVSASR50	420.00
65	✓	✓	✓	✓	✓	BFVDA65	384.00	BFVSASR65	424.00
80	✓	✓	✓	✓	✓	BFVDA80	402.00	BFVSASR80	492.00
100	✓	✓	✓	✓	✓	BFVDA100	472.00	BFVSASR100	612.00
125	✓	✓	✓	✓	✓	BFVDA125	564.00	BFVSASR125	770.00
150	✓	✓	✓	✓	✓	BFVDA150	744.00	BFVSASR150	1040.00
200	✓	✓	✓	✓	✓	BFVDA200	POA	BFVSASR200	POA
250	✓	✓	✓	✓	✓	BFVDA250	POA	BFVSASR250	POA
300	✓	✓	✓	✓	✓	BFVDA300	POA	BFVSASR300	POA

NITRILE Seat = Nitrile Butadiene, (Buna-N)
 Max Temp = 100°C Min Temp = -18°C
 Suitable for general applications, including sanitary and some hydrocarbon services.

Other seat materials available on request.

AIR ACTUATORS
 OPERATING PRESSURE – 6 BAR.
 FOR OPEN/CLOSE CONTROL, REFER
 TO SOLENOID/PILOT VALVES



PRICES DO NOT INCLUDE GST
 E&O.E

BUTTERFLY VALVE PLUS ELECTRIC ACTUATORS

SIZE N.B.	TABLE E	E.P.D.M. SEAT	WAFER C.I. BODY	316 S/S DISC	316 S/S STEM	VALVE COMPLETE WITH ELECTRIC ACTUATOR ON/OFF 24V AC/DC	LIST \$/EACH	VALVE COMPLETE WITH ELECTRIC ACTUATOR ON/OFF 110/240V AC	LIST \$/EACH
50	✓	✓	✓	✓	✓	BFVEA5024ACDC	978.00	BFVEA50110240AC	1112.00
65	✓	✓	✓	✓	✓	BFVEA6524ACDC	988.00	BFVEA65110240AC	1122.00
80	✓	✓	✓	✓	✓	BFVEA8024ACDC	1090.00	BFVEA80110240AC	1290.00
100	✓	✓	✓	✓	✓	BFVEA10024ACDC	1104.00	BFVEA100110240AC	1308.00
125	✓	✓	✓	✓	✓	BFVEA12524ACDC	1556.00	BFVEA125110240AC	1792.00
150	✓	✓	✓	✓	✓	BFVEA15024ACDC	1770.00	BFVEA150110240AC	2024.00
200	✓	✓	✓	✓	✓	BFVEA20024ACDC	POA	BFVEA200110240AC	POA
250	✓	✓	✓	✓	✓	BFVEA25024ACDC	POA	BFVEA250110240AC	POA
300	✓	✓	✓	✓	✓	BFVEA30024ACDC	POA	BFVEA300110240AC	POA

The VALBIA electric actuators are suitable for the automation of ball and butterfly valves. The range has been manufactured with the following characteristics:

- The housing of the actuators provides a W0 self-extinguishing Class techno-polymer material.
- The kinematics is made by two steel and techno-polymer gear wheels, sustained by hardened steel pinions, mounted on self-lubricating bushes (excluding Mod. VB015), and inserted.
- The connection part of the actuators with the valves is made by a die-casted and painted aluminium plate, with a dual drilling interface as per the ISO5211 – DIN 3337 Standard.
- The electronic circuit automatically adjusts the motor speed depending on the mechanical charge variations in order to drive the cycle always in the same time.
- All actuators are provided with an electronic system for torque limitation.
- A heating resistance is activated, by powered actuator, once the temperature inside the housing drops below 77°F (25°C) and the motor is not running.
- On request, (MOD. VB015 excluded) electric actuators with modulating option 4-20mA or 0-10V, or with battery block for safety operation, can be supplied.



PRICES DO NOT INCLUDE GST
E&O.E

NAMUR 5/2 SOLENOID AND PILOT OPERATED VALVES

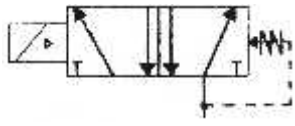
PART No.	ISO SYMBOL	LIST \$/EACH
ENS125*  <p>*Valve comes complete with coil. Please specify voltage code from table below.</p>		128.33

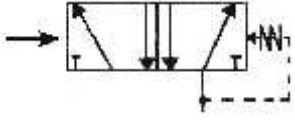
PART No.	ISO SYMBOL	LIST \$/EACH
ENPS25 		197.14

NAMUR SOLENOID VALVE COIL TABLE

VOLTAGE	PART No.	CODE	LIST \$/EACH
240/50HZ	ENC240AC	1	208.60
110/50HZ	ENC110AC	2	195.30
24/50HZ	ENC24AC	5	89.50
12VDC	ENC12DC	7	89.50
24VDC	ENC24DC	8	89.50
415/50HZ	ENC415AC	11	89.50

TOGGLE/TOGGLE 1/8" BSP 3/2

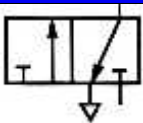
PART No.	ISO SYMBOL	LIST \$/EACH
TTAV1832		265.80

Note: can be used to provide the pilot control signal to a Namur pilot operated valve directly mounted on a pneumatic actuator for on/off operation.

TOGGLE/TOGGLE 1/8" BSP 5/2

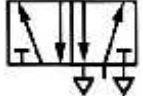
PART No.	ISO SYMBOL	LIST \$/EACH
TTAV1852		288.45

Note: can be used to directly control a pneumatic actuator for on/off operation.

PRICES DO NOT INCLUDE GST
E&O.E

LEGRIS FILTER REGULATORS & LUBRICATORS

AIR SERVICE UNITS – SERIES STANDARD

6700 Filter/Regulator 1 unit

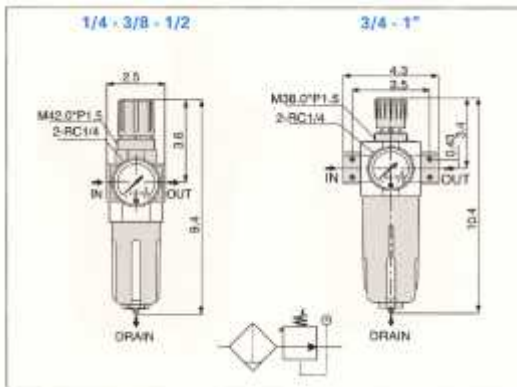

Specification

Threaded port (BSPP)	1/4	3/8	1/2	3/4	1"
Maximum flow rate (NI/min)	2100	2130	2750	8000	8500
Filter bowl capacity (cc)	105	105	105	210	210
Lubricator oil	ISO – VG32 recommended (or equivalent)				
Weight (kg)	0,930	0,930	0,930	1,360	1,360

Flow charts

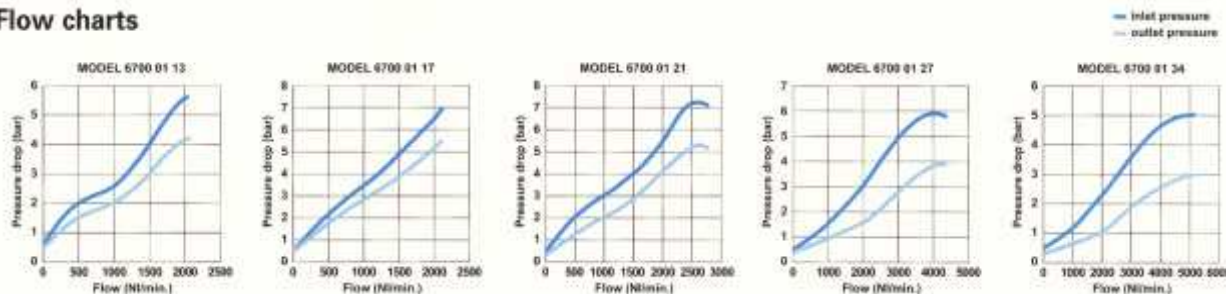

PORT	DRAIN	FILTER MICRON	PART No.		LIST \$/EACH
1/4"	Manual	5μ	6700 01 13	Standard	93.78
1/4"	Manual	40μ	6700 41 13	Option	93.78
1/4"	Semi Auto	5μ	6700 03 13	Option	96.18
1/4"	Semi Auto	40μ	6700 43 13	Option	96.18
3/8"	Manual	5μ	6700 01 17	Standard	98.70
3/8"	Manual	40μ	6700 41 17	Option	98.70
3/8"	Semi Auto	5μ	6700 03 17	Option	101.10
3/8"	Semi Auto	40μ	6700 43 17	Option	101.10
1/2"	Manual	5μ	6700 01 21	Standard	102.18
1/2"	Manual	40μ	6700 41 21	Option	102.18
1/2"	Semi Auto	5μ	6700 03 21	Option	103.14
1/2"	Semi Auto	40μ	6700 43 21	Option	103.14
3/4"	Manual	5μ	6700 01 27	Standard	196.98
3/4"	Manual	40μ	6700 41 27	Option	196.98
3/4"	Semi Auto	5μ	6700 03 27	Option	199.50
3/4"	Semi Auto	40μ	6700 43 27	Option	199.50
1"	Manual	5μ	6700 01 34	Standard	204.54
1"	Manual	40μ	6700 41 34	Option	204.54
1"	Semi Auto	5μ	6700 03 34	Option	208.62
1"	Semi Auto	40μ	6700 43 34	Option	208.62

Also available on request: threaded ports 1 1/2" and 2".

Ready to be mounted.
The products are delivered with following accessories:

- 1 gauge
- 1 bracket (sizes 1/4, 3/8, 1/2) or 2 brackets (sizes 3/4, 1").
- 4 screws
- 1 plug

PRICES DO NOT INCLUDE GST
E&O.E

LEGRIS FILTER REGULATORS & LUBRICATORS

AIR SERVICE UNITS – SERIES STANDARD

6707 Filter/Regulator – Lubricator 2 units



Specification

Threaded port (BSPP)	1/4	3/8	1/2	3/4	1"
Maximum flow rate (NI/min)	2080	2100	2600	7940	8200
Filter bowl capacity (cc)	105	105	105	210	210
Lubricator oil	ISO – VG32 recommended (or equivalent)				
Weight (kg)	1,480	1,480	1,480	2,150	2,150

Flow charts

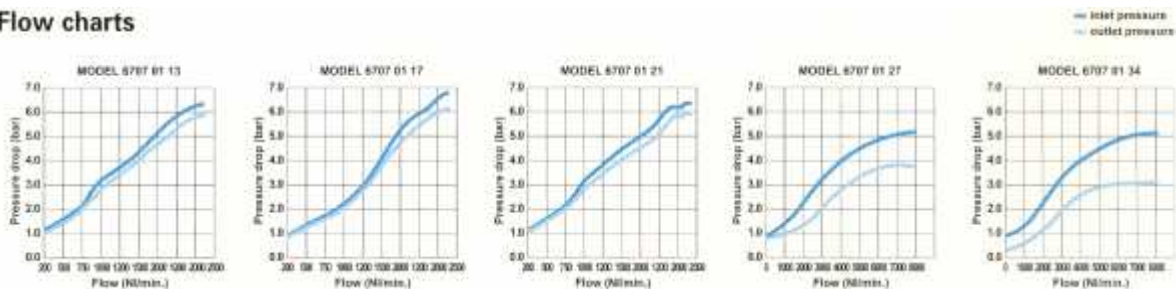

PORT	DRAIN	FILTER MICRON	PART No.		LIST \$/EACH
1/4"	Manual	5µ	6707 01 13	Standard	117.90
1/4"	Manual	40µ	6707 41 13	Option	117.90
1/4"	Semi Auto	5µ	6707 03 13	Option	123.84
1/4"	Semi Auto	40µ	6707 43 13	Option	123.84
3/8"	Manual	5µ	6707 01 17	Standard	126.48
3/8"	Manual	40µ	6707 41 17	Option	126.48
3/8"	Semi Auto	5µ	6707 03 17	Option	128.70
3/8"	Semi Auto	40µ	6707 43 17	Option	128.70
1/2"	Manual	5µ	6707 01 21	Standard	133.44
1/2"	Manual	40µ	6707 41 21	Option	133.44
1/2"	Semi Auto	5µ	6707 03 21	Option	136.08
1/2"	Semi Auto	40µ	6707 43 21	Option	136.08
3/4"	Manual	5µ	6707 01 27	Standard	255.78
3/4"	Manual	40µ	6707 41 27	Option	255.78
3/4"	Semi Auto	5µ	6707 03 27	Option	258.18
3/4"	Semi Auto	40µ	6707 43 27	Option	258.18
1"	Manual	5µ	6707 01 34	Standard	302.40
1"	Manual	40µ	6707 41 34	Option	302.40
1"	Semi Auto	5µ	6707 03 34	Option	306.12
1"	Semi Auto	40µ	6707 43 34	Option	306.12

Also available on request: threaded ports 1 1/2" and 2".

Ready to be mounted
The products are delivered with following accessories:

- 1 gauge
- 1 bracket (sizes 1/4, 3/8, 1/2) or 2 brackets (sizes 3/4, 1").
- 4 screws
- 1 plug

PRICES DO NOT INCLUDE GST
E&O.E

COMPRESSED AIR FILTER/REGULATOR

Economy model, aluminium body, P.C. bowl, metal bowl shield, with manual drain.



SIZE INCH	PART No.	FILTRATION	MAXIMUM PRESSURE	ADJUSTABLE REGULATING RANGE	TEMPERATURE RANGE	VALVE TYPE	GAUGE PORT	LIST \$/EACH
1/4	TW3000-02	5 micron	1.0 MPa	0.05-0.85 MPa	0-60°C	Relief	1/8"	65.00

PRICES DO NOT INCLUDE GST
E&O.E

FLOAT VALVES AND ACCESSORIES

ACETYL FLOAT VALVES



SIZE INCH	SIZE MM	PART No.	DESCRIPTION	LIST \$/EACH
1/2	15	AIPATV15	15mm Acetyl Full Flow Float Valve	37.40
3/4	20	AIPATV20LSA	20mm Acetyl Full Flow Float Valve Long Thread c/w Backnut – Short Arm	37.40
3/4	20	AIPATV20LLA	20mm Acetyl Full Flow Float Valve Long Thread c/w Backnut – Long Arm	37.40
1	25	AIPATV25LSA	25mm Acetyl Full Flow Float Valve Long Thread c/w Backnut – Short Arm	37.40
1	25	AIPATV25LLA	25mm Acetyl Full Flow Float Valve Long Thread c/w Backnut – Long Arm	37.40

ACETYL LARGE FLOAT VALVES



SIZE INCH	SIZE MM	PART No.	DESCRIPTION	LIST \$/EACH
1 1/4	32	AIPATV32	32mm Acetyl Float Valve Single Arm	221.65
1 1/4	32	AIPATV32DA	32mm Acetyl Float Valve Dual Arm	336.05
1 1/2	38	AIPATV38	38mm Acetyl Float Valve Single Arm	221.65
1 1/2	38	AIPATV38DA	38mm Acetyl Float Valve Dual Arm	336.05
2	50	AIPATV50	50mm Acetyl Float Valve Single Arm	221.65
2	50	AIPATV50DA	50mm Acetyl Float Valve Dual Arm	336.05

BRASS FLOAT VALVE

SIZE INCH	SIZE MM	PART No.	DESCRIPTION	LIST \$/EACH
3/4	20	AIPBTV20	20mm Brass Full Flow Trough Valve	85.50
1	25	AIPBTV25	25mm Brass Full Flow Trough Valve	85.50



BALL FLOATS AND VALVE PARTS

	PART No.	DESCRIPTION	LIST \$/EACH
	AIPBF115	115mm Float Ball	5.72
	AIPBF150	150mm Float Ball	9.10
	AIPBF150/O	150mm Float Ball (Orange)	9.10
	TVCNP	Plastic Cord & Nipple	6.05
	TVCNB	Brass Cord & Nipple	7.29

PRICES DO NOT INCLUDE GST
E&O.E

STAINLESS STEEL STRAINERS

	SIZE INCH	SIZE MM	PART No.	LIST \$/EACH
	3/8	10	SSS10	5.28
	1/2	12	SSS12	4.20
	3/4	20	SSS20	4.31
	1	25	SSS25	5.94
	1 1/4	32	SSS32	7.87
	1 1/2	38	SSS38	9.48
	2	50	SSS50	12.07
	2 1/2	65	SSS65	26.02
	3	75	SSS75	29.82
4	100	SSS100	41.82	

CARBON STEEL FILTERS

	SIZE INCH	SIZE MM	PART No.	LIST \$/EACH
	1 1/2	38	CSF38	35.94
	2	50	CSF50	39.99
	2 1/2	65	CSF65	41.82
	3	75	CSF75	54.89
	4	100	CSF100	63.82
	6	150	CSF150	POA

POLYPROPYLENE STRAINERS

	SIZE INCH	SIZE MM	PART No.	LIST \$/EACH
	1 1/4	32	PST32	11.99
	1 1/2	38	PST38	12.58
	2	50	PST50	13.73
	3	75	PST75	14.30

BRASS FOOT VALVE

	SIZE INCH	SIZE MM	PART No.	LIST \$/EACH
	1/2	12	BFV12	23.04
	3/4	20	BFV20	23.52
	1	25	BFV25	27.10
	1 1/4	32	BFV32	37.68
	1 1/2	38	BFV38	50.84
	2	50	BFV50	69.86
	2 1/2	65	BFV65	119.76
	3	75	BFV75	163.00
	4	100	BFV100	289.40

GALVANIZED QUICK RELEASE FOOT VALVE (SWING FLAP TYPE)

	SIZE INCH	SIZE MM	PART No.	LIST \$/EACH
	3	75	GFV75	363.83
	4	100	GFV100	425.70
	6	150	GFV150	581.63
	8	200	GFV200	841.50
	10	250	GFV250	1460.25
	12	300	GFV300	1769.65

Also available in 304 stainless steel POA.

PRICES DO NOT INCLUDE GST
E&O.E

BRASS HOSE COCKS & ACCESSORIES

BRASS HOSE COCK – DR WATERMARK R/B T HEAD MALE

	SIZE INCH	SIZE MM	PART No.	LIST \$/EACH
	1/2	12	BHC12	14.85
	3/4	20	BHC20	16.95

BRASS HOSE COCK – BACK PLATED R/B T HEAD MALE

	SIZE INCH	SIZE MM	PART No.	LIST \$/EACH
	1/2	12	BHCBP12	24.68
	3/4	20	BHCBP20	29.78

EZY TURN TAP HANDLE (YELLOW & GREEN)

Clicks onto the top of the tap handle for ease of turning.

	SIZE INCH	SIZE MM	PART No.	LIST \$/EACH
	1/2	12	EZTH	4.45
	3/4	20	EZTH	4.45

VACUUM BREAKER

(To suit brass hose cocks.)

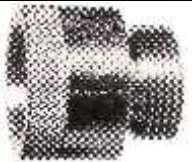
	SIZE INCH	SIZE MM	PART No.	MAX W.P.	MAX TEMP °C	LIST \$/EACH
	1/2	12	VB12	200 PSI	80	16.85
	3/4	20	VB20	200 PSI	80	17.25
	1	25	VB25	200 PSI	80	33.50

JUMPER VALVES

(To suit brass hose cocks.)

	SIZE INCH	SIZE MM	PART No.	DESCRIPTION	LIST \$/EACH
	1/2	12	PJV12	12mm Plastic Jumper Valve	0.52
	3/4	20	PJV20	20mm Plastic Jumper Valve	0.95
	1/2	12	BJV12	12mm Brass Jumper Valve	4.30
	3/4	20	BJV20	20mm Brass Jumper Valve	4.30

DUAL CHECK VALVE

	SIZE INCH	SIZE MM	PART No.	LIST \$/EACH
	1/2	12	DCV12	POA
	3/4	20	DCV20	69.75
	1	25	DCV25	69.75

PRICES DO NOT INCLUDE GST
E&O.E

AIP PTFE THREAD TAPE

	SIZE	COLOUR	PART No.	LIST \$/ROLL
	12mm x 10mtr	Premium White	TTPW1210	1.30
	12mm x 30mtr	Premium White	TTPW1230	3.90
	25mm x 10mtr	Premium White	TTPW2510	2.60
	12mm x 10mtr	Premium Pink	TTPP1210	4.59
	12mm x 30mtr	Premium Pink	TTPP1230	13.77
	12mm x 10mtr	Yellow Gas Tape AGA Approved	TTAGAY1210	5.25
	12mm x 30mtr	Yellow Gas Tape AGA Approved	TTAGAY1230	27.72

AIP DUCT TAPE

	PART No.	ROLL SIZE	CARTON QTY	COLOUR	LIST \$/ROLL
	SDT4830	0.15mm x 48mm x 30mtr	60	Silver	4.90
	SDT7230	0.15mm x 72mm x 30mtr	48	Silver	7.34
	BDT4830	0.15mm x 48mm x 30mtr	60	Black	5.20

PRICES DO NOT INCLUDE GST
E&O.E

NOZZLES AND WASHDOWN GUNS

ALUMINIUM NOZZLES – FARM TANK EQUIPMENT

25MM S.F.E. TRIGGER NOZZLE FOR LEADED FUEL WITH VITON 'O' RING			
	PART No.	SIZE MM BSP	LIST \$/EACH
	FTE25	25	51.84

19MM S.F.E. TRIGGER NOZZLE FOR UNLEADED FUEL WITH VITON 'O' RING			
	PART No.	SIZE MM BSP	LIST \$/EACH
	ULF25	25	69.30

25MM S.F.E. SLUMP GUN FOR USE WITH CONCRETE TRUCKS OR OTHER APPLICATIONS WHERE HIGHER PRESSURE WATER IS NEEDED. CASE HARDENED TRIGGER.			
	PART No.	SIZE MM BSP	LIST \$/EACH
	TWG25	25	88.45

HOT WATER WASHDOWN GUN

Rubber coated handle protects against heat transfer up to 75°C. Low pressure cleaning – food and dairy processing, abattoirs, mining, industrial. ½" BSP female inlet. Variable spray pattern. 25 L/M at 70 psi. Maximum pressure rating 20 bar.

	PART No.	SIZE INCH	LIST \$/EACH
	GWG12	½" BSP (Female)	264.60

HEAVY DUTY ADJUSTABLE SPRAY NOZZLE

Commercial grade professional nozzle with protective rubber moulding, for heavy duty applications.

	PART No.	SIZE INCH	LIST \$/EACH
	RB7302C	¾" BSP (Female)	48.60

ADJUSTABLE SPRAY NOZZLE

	PART No.	SIZE INCH	LIST \$/EACH
	K42	1" BSP (Female)	38.60

PRICES DO NOT INCLUDE GST
E&O.E

HOSE NOZZLES & ADAPTORS

LARGE POWER JET NOZZLE		
	<p>PERFORMANCE TEST RESULTS POWERJET NOZZLE</p> 	<p>MADE FROM TOUGH POLYCARBONATE POLYMER</p> <p>ADAPTOR SIZES 19, 25, 32, 38mm</p>
PART No.	THREAD SIZE MM	LIST \$/EACH
LHN38	38	45.98
SMALL POWER JET NOZZLE		
	<p>PERFORMANCE TEST RESULTS SMALL POWERJET NOZZLE</p> 	<p>MADE FROM TOUGH POLYCARBONATE POLYMER</p> <p>ADAPTOR SIZES 19, 25, 32mm</p>
PART No.	THREAD SIZE MM	LIST \$/EACH
SHN25	25	37.18
HOSE REEL NOZZLE		
	<p>PERFORMANCE TEST RESULTS HOSE REEL NOZZLE</p> 	<p>MADE FROM TOUGH POLYCARBONATE POLYMER</p> <p>ADAPTOR SIZES 13, 19, 25mm</p>
PART No.	THREAD SIZE MM	LIST \$/EACH
HRN20	20	31.00
POWER SPRAY NOZZLE		
		<p>MADE FROM SUPER TOUGH NYLON 6</p> <p>ADAPTOR SIZES 13, 19, 25mm</p>
PART No.	THREAD SIZE MM	LIST \$/EACH
PSN20	20	21.25

PRICES DO NOT INCLUDE GST
E&O.E

HEAVY DUTY HOSE NOZZLES

Produced from high quality industrial plastics, for greater impact resistance.

HOSE NOZZLE (BSP THREAD)

	PART No.	DESCRIPTION	LIST \$/EACH
	AHNS25	Small 25mm	50.55
	AHNS32	Small 32mm	51.60
	AHNL32	Large 32mm	70.30
	AHNL40	Large 40mm	76.78

HOSE TAILS TO SUIT (BSP THREAD)

	PART No.	SIZE	LIST \$/EACH
	AHT25	25mm	4.20
	AHT32	32mm	5.12
	AHT40	40mm	5.53
	AHT32X25	32mm x 25mm	5.28
	AHT40X32	40mm x 32mm	4.84

Performance Curve (large hose nozzle)

Pump: 80 x 50-200 to 18.5kW, 2 pole WEG Tested 30/7/99 for ANKA Ltd. 32mm & 40mm Nozzles.

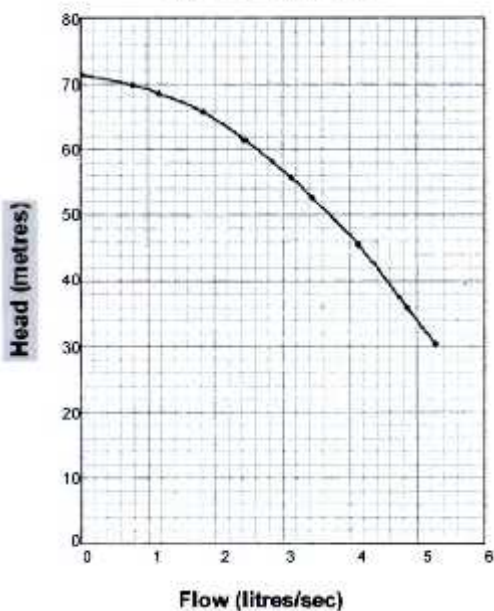

Performance Curve (small hose nozzle)

Pump: 100 x 80-160 to 15kW, 2 pole WEG Tested 31/7/00 for ANKA Ltd. 25mm & 32mm Nozzles.

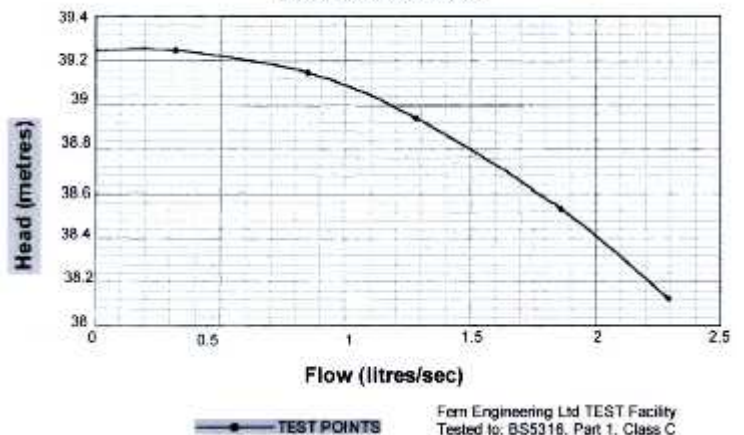







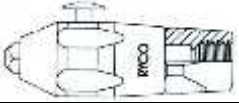

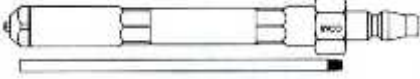

PRICES DO NOT INCLUDE GST
E&O.E

BLOW GUNS

AIP EASY HAND CLASP BLOW GUN COMPLETE WITH 20PM QUICK CONNECT FITTING			
	THREAD	PART No.	LIST \$/EACH
		¼ BSPP	AIPBG

PUSH-BUTTON BLOW GUN			
	THREAD	PART No.	LIST \$/EACH
		¼ BSPP	RYCO223

AIR-FLEX BLOW GUNS					
<ul style="list-style-type: none"> Leakproof internal valve Operates by slight pressure between hand & thumb Relaxing pressure instantly shuts air off Includes part no. 2215 extension 					
					
COUPLING STYLE	PART No.	LIST \$/EACH	COUPLING STYLE	PART No.	LIST \$/EACH
200 SERIES	RYCO222	36.39	400 SERIES	RYCO422	36.39
290 SERIES	RYCO222	36.39	500 SERIES	RYCO522	36.39
					
THREAD		PART No.		LIST \$/EACH	
¼ BSPP		RYCO221		36.39	

	PART No.	DESCRIPTION	LIST \$/EACH
	JMP070770	Blowgun with extension nozzle and angled tip. Nozzle can be adjusted through 360 degrees.	36.00
	JMP070771	Blowgun with conical nozzle.	34.69
	JMP070772	Blowgun with contour nozzle. Safety features: low noise, adjustable nozzle, high volume of air.	61.10
	JMP070640	Pistol grip blowgun.	40.00
	JMP070600	J-P air blower with extension nozzle and angled tip. Nozzle can be adjusted through 360 degrees. (14cfm at 90 psi)	35.15
	JMP040515	Long nose button. (7cfm at 90 psi)	25.48
	JMP070780	Safe-n-Quiet blowgun. Silent/safety nozzle, low noise level. 77-84Db(A) controlled air flow.	60.18

PRICES DO NOT INCLUDE GST
E&O.E

POWAFLEX®

QUALITY RUBBER, PVC & POLYURETHANE HOSE



Copyright Notice

© Advanced Industrial Products Pty Ltd 2012

This product catalogue and price list and its contents are subject to copyright under the laws of Australia and, through international treaties, other countries. The copyright is owned by Advanced Industrial Products Pty Ltd, or in the case of some of the materials, by third parties.

The material in this product catalogue and price list is for personal use only and may not be used for any other purpose without the prior written consent of Advanced Industrial Products Pty Ltd. You must not reproduce, transmit, adapt or otherwise exercise the copyright in the whole or any part of

this product catalogue and price list except with the prior written consent of Advanced Industrial Products Pty Ltd.

TERMS AND CONDITIONS OF SALE

1 EXCLUSION OF BUYER'S TERMS

- 1.1 It is expressly acknowledged and agreed that these terms operate to the exclusion of all and any terms and conditions issued by the Buyer whether before or after the date these conditions of sale come into effect.

2 ORDERS AND PERFORMANCE

- 2.1 The Company may make its acceptance of an order conditional upon a satisfactory credit assessment of the Buyer.
- 2.2 Unless otherwise agreed orders must be confirmed in writing and either mailed, couriered, or faxed.
- 2.3 The Company will use its best endeavours to fulfill accepted orders and comply with any requested or estimated date for delivery but time will not be of the essence in this regard and if the Company's ability to fulfill an accepted order is affected by circumstances or events beyond its control the Company may:
- (a) extend the date for delivery;
 - (b) with the Buyer's approval, alter the specifications for the goods to allow the substitution of equivalent goods; or
 - (c) cancel the order without liability for breach.
- 2.4 The Company's policy is one of constant improvement and therefore changes of specifications and performance data may be made by the Company without notice and without incurring liability to the Buyer.

3 PRICE

- 3.1 Prices charged for goods will be according to a Current Quotation for those goods. Otherwise they will be determined by the Company by reference to its standard prices in effect at the date of Delivery (whether notified to the Buyer or not and regardless of any prices contained in the order). The Company will use its best endeavours to notify the Buyer of price changes but bears no liability in this regard.
- 3.2 Unless specifically indicated, prices in quotation or elsewhere do not include insurance, special packing, delivery or tax.
- 3.3 Any reference to resale prices contained in the Company's standard price lists or other documents (if any) are recommended resale prices only and there is no obligation on the Buyer to comply with these recommendations.
- 3.4 Prices shown in the Company's price list are exclusive of GST unless otherwise stated and GST, where applicable, will be charged in accordance with current legislation.
- 3.5 The Buyer will be liable for all applicable taxes to the extent that they are not already included in the price.

4 DELIVERY AND PACKING

- 4.1 Unless otherwise agreed, goods sold to the Buyer shall be supplied ex the Company's premises, and FOB.
- 4.2 Unless otherwise agreed, prices include standard packing by the Company and any special packing will be to the Buyer's account.

5 PAYMENT

- 5.1 Terms of payment by the Buyer will be by net cash in exchange for goods; for Buyers fulfilling the Company's credit requirements - net cash within 30 days from the end of the month in which the invoice was issued; or otherwise as agreed in writing.
- 5.2 The Company will provide an invoice to the Buyer who will pay the invoice in full within the time specified.
- 5.3 All payments to the Company will be made without set-off, deduction or counterclaim.
- 5.4 If the Buyer fails to pay the invoice in full to the Company when due, the Company will be entitled (without prejudice to any other right or remedy it may have) to:
- (a) cancel or suspend any further delivery to the Buyer under any order; and
 - (b) charge the Buyer interest on the overdue amount at the rate of 15% p.a. from the date of invoice to the date of full and final payment (irrespective of whether the date of payment is before or after any judgment or award in respect of the overdue amount).
 - (c) Charge to the Buyer all third party costs incurred in demanding and recovery of payments due or recovery of goods.
 - (d) to enter the buyer's premises or the delivery site (or the premises of any associated Company or agent where the Goods are located) without liability for trespass or any resulting damage and retake possession of the goods.

6 CLAIMS

- 6.1 Any claim by the Buyer for incorrect orders, shortages, overcharges and the like will only be considered by the Company if made in writing and forwarded within 14 days of the date of the invoice to the Company's claims department.
- 6.2 Any claims by the Buyer for goods lost or damaged in transit following Delivery should be made to the relevant carrier or transport authority and unless otherwise agreed the Company is not responsible for such loss or damage.
- 6.3 Return of goods to the Company by the Buyer may only be made if the Company has agreed to that return and all such returns will be subject to a 15% handling charge with freight costs and risk remaining the responsibility of the Buyer, subject always to clause 8.

7 INSURANCE, RISK AND PROPERTY

- 7.1 Unless otherwise agreed, goods are not insured by the Company.
- 7.2 Title to all the goods delivered by the Company to the Buyer remains with the Company and does not pass to the Buyer until the Buyer pays all monies due for all goods supplied in cleared funds, regardless of whether certain goods have already been paid for by the Buyer.
- 7.3 If the Buyer pays a portion of an amount due to the Company for goods delivered to them, the Company retains all title to those goods until the Buyer makes full payment for the goods.
- 7.4 If the Buyer enters into an agreement for the bona fide sale to a third party for a portion of goods delivered by the Company to the Buyer, title only passes to the Buyer in respect of the goods that the third party is purchasing. Title to the remaining goods not purchased by the third party remains with the company until the Buyer has complied with clause 7.2.

8 WARRANTIES

- 8.1 All goods are warranted to the level provided by the manufacturer, the period commencing from the date of invoice by this Company to its customers. The return of goods shall be at the customer's expense and the Company reserves the right to repair or replace goods under warranty claim.
- 8.2 To the fullest extent permitted by law the Company will not be liable to the Buyer for loss of profit or other economic loss; direct, indirect or consequential loss; special, general or other damages; or other expenses or costs arising out of any breach of the Contract or any common law duty (including negligence) by the Company, its agents or employees.

9 OTHER ITEMS

- 9.1 The Company will be entitled to off set against any monies owing to the Buyer amounts owed to the Company by the Buyer under the Contract or on any other account.

10 MISCELLANEOUS

- 10.1 Each party acknowledges and agrees that:
- (a) the Contract represents the entire agreement between the parties and supersedes all previous agreements;
 - (b) it has not entered into the Contract in reliance on, or as a result of any statement or conduct of any kind (including without limitation, any representation, warranty, advice or undertaking);
 - (c) all conditions, warranties or other terms implied by statute or common law are excluded to the fullest extent permitted by law;
 - (d) the Contract may only be amended by agreement in writing.

11 DEFINITIONS AND INTERPRETATION

In these Conditions of Sale the following terms have the following meanings unless the context requires otherwise:

'Buyer' means a person from whom the Company accepts an order for goods.

'Contract' means the agreement constituted by the Company's acceptance of the Buyer's order and includes these Conditions of Sale.

'Delivery' means delivery of any goods to the Buyer or to a carrier arranged by the Buyer or the Company at the Buyer's request.

'Tax' means any tax, levy, charge or duty imposed by any governmental entity or authority (including, without limitation, GST and customs duty) on or in relation to goods sold to the Buyer (excluding taxes on the company's income and capital gains).

'Company' is that entity, the name of which appears on the face of the relevant invoice.

12 LEGAL JURISDICTION

These terms and conditions shall be governed by the laws of the State of Queensland notwithstanding the place in which the goods or any of them are to be delivered. The Customer submits to the exclusive Jurisdiction of the Courts of the State of Queensland.